



**B. ALI IMPEX**

# **GYNECOLOGICAL INSTRUMENTS**

 :+92-300-8610659  
 :+92-301-8610659  
 :usman@baliimpex.com  
 :info@baliimpex.com  
**Web: .www.baliimpex.com**



INDEX	B.ALI IMPEX	GYNE INSTRUMENTS	
<b>A</b>			
	Anoscope Rectal Retractors		2
	Anoscope Proctoscopes		3
	Aborts Zangen obstetrical forceps		39
<b>B</b>			
	Biopsy curettes		26
	Bone curettes		44-46
<b>C</b>			
	Cervical Biopsy and specimen forceps		34-36
	Cervical biopsy and obstetrical forceps		37-38
	Comedo extractors		42
<b>D</b>			
	Dermal punches, nail instruments		41
	Dissectors , Elecators		47
<b>H</b>			
	Haemorroidal forceps fistula probes		5
<b>M</b>			
	myoma instruments		27
<b>N</b>			
	Nail instruments		43
<b>O</b>			
	Obstetrical forceps		37-38
<b>p</b>			
	Polypus and ovum forceps		24
	Placenta and ovum forceps		40
<b>R</b>			
	Rectal specula		1
	Rectal biopsy forceps		4
<b>S</b>			
	Speculum intrauterine probe		17
<b>U</b>			
	Uterine dilators /uterus dilatator		18-19
	Uterine probes , graduated in centimeters		25
	Uterine tenaculum forceps		20-23
	Uterine elevating forceps		24
	Uterine curettes		28-33
<b>V</b>			
	Vaginal specula		6-14
	Vaginalspecula and retractors		15-16

Mastdarm-Rektum-Spekula  
 Rectal Specula  
 Espéculos para el recto  
 Speculi rettali

17 x 89 mm



17 x 89 mm



MATHIEU  
 21,0 cm, 8 1/4"  
 14-2263-21

75 x 23 mm



SMITH-BUIE  
 15,0 cm, 6"  
 14-2264-15

Analspreizer, Sphinkterskope,  
 AnuskopeRectal Retractor,  
 Sphinkterscopes, Anoscope  
 Separadores para el recto, Esfinteroscopios, Anoscopios  
 Dilatatori per l'ano ed, il retti, Sfinteroscopi, Anoscopi



14-2266-00



HAYES



HIRSCHMANN

Anuskope, Proktoskope  
Anoscope, Proctoscopes  
Anoscopios, Proctoscopios  
Anoscopi, Protoscopi



Ø 22 x 65 mm 14-2269-22  
Ø 30 x 65 mm 14-2269-30

**CHEL SEAEATON**



Ø 22 Kaltlichtträger  
without cold light carrier  
sin portador para luz fría  
senza luce fredda

**IVE SFAN SLER**  
Ø 22 mm  
14-2270-01

Ø 22 Kaltlichtträger  
with cold light carrier  
con portador para luz fría  
con luce fredda

**IVE SFAN SLER**  
Ø 22 mm  
14-2271-02



Ø17x6565mm 14-2272-01  
Ø17x80mm 14-2272-02  
Ø20x65mm 14-2272-03  
Ø20x80mm 14-2272-04  
Ø24x65mm 14-2272-05  
Ø24 x 80 mm 14-2272-06

**MORGAN**

055-1000-02



Ø25x6565mm 14-2273-25  
Ø25x65mm 14-2273-29  
Ø38 x 70 mm 14-2273-38

**FAN SLER**

Mastdarm-Biopsiezangen  
Rectal Biopsy Forceps  
Pinças sacabocado para biopsia rectal  
Pinze taglienti per biopsia rettale

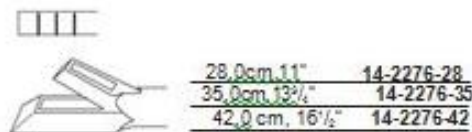
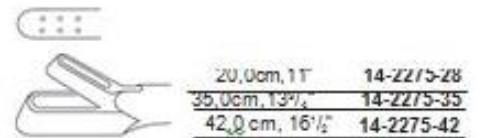
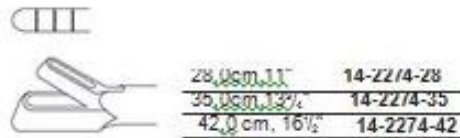

14-2278-00

14-2279-00

∅ 12,0 mm

∅ 12,0 mm

Hamorroiden-Ligator mit Ladekonus  
Haemorrhoidal ligator with loading attachment  
Ligador para hemorroides con cono de carga  
Legatori emorroidali con canca a cono



Hamorroiden-Ligator mit Ladekonus  
Haemorrhoidal ligator with loading attachment  
Ligador para hemorroides con cono de carga  
Legatori emorroidali con canca a cono

RUDD  
14-2280-00



MCGIVNEY  
14-2281-00

Hämorrhoiden-Faßzangen, Fistelsonden  
Haemorrhoidal Forceps, Fistula probes  
Pinza-clamps para hemorroides, Sondas para fistula  
Pinze per emorroidi, Sonde per fistola



**MCGIVNEY**  
19,0 cm, 7 1/2"  
14-2282-19



**MCGIVNEY**  
19,0 cm, 1/2"  
14-2283-19



**PRATT**  
21,0 cm, 8 1/4"



14-2284-01



14-2284-02



14-2284-03

Scheidenspekula  
 Vaginal Specula  
 Espéculos vaginales  
 Speculi vaginali

für  
 Kindertor  
 children  
 para niños  
 per bambini



**COLLIN**  
 65 x 10 mm  
 14-2285-00

für Jungfrauen  
 for virgins para  
 virgenes per  
 vergini



**COLLIN5**  
 5 x 10 mm  
 14-2286-00



**COLLIN**  

85 x 30 mm	14-2287-01
100 x 35 mm	14-2287-02
110 x 40 mm	14-2287-03



**CUSCO**  

80x24mm	14-2288-01
80x32mm	14-2288-02
98x16mm	14-2288-03
105x25mm	14-2288-04
107x29mm	14-2288-05
115 x 35 mm	14-2288-06



Scheidenspekula  
Vaginal Specula  
Especulos vaginales  
Speculi vaginali

zentrale Stellschraube  
central fixation screw  
tornillo de sujeto  
centralvite di regolazione  
centrale



CUSCO

75 x 32 mm	14-2289-01
85 x 36 mm	14-2289-02
95 x 37 mm	14-2289-03

seitliche Stellschraube  
lateral fixation screw  
tornillo de sujeto lateralvite  
di regolazione laterale



für Jungfrauen  
for virgins para  
virgenes per  
vergini

CUSCO  
75 x 17 mm  
14-2290-00

seitliche Stellschraube  
lateral fixation screw  
tornillo de sujeto  
lateralvite di regolazione  
laterale



CUSCO

75 x 32 mm	14-2291-01
85 x 35 mm	14-2291-02
100 x 35 mm	14-2291-03

Schweizer Model  
Swiss pattern  
Modelo suizo  
Modello svizzero



CUSCO

90 x 23-25 mm	14-2292-01
100 x 25-27 mm	14-2292-02
110 x 27-30 mm	14-2292-03

Scheidenspekula  
 Vaginal Specula  
 Espéculos vaginales  
 Speculi vaginali



**GRAVE**  
 75 x 20 mm 14-2293-01  
 95 x 35 mm 14-2293-02  
 115 x 35 mm 14-2293-03



**PEDER SON**  
 75 x 13 mm 14-2294-01  
 100 x 22 mm 14-2294-02  
 120 x 25 mm 14-2294-03



**SEMM**  
 90 x 14-18 mm 14-2295-01  
 100 x 17-20 mm 14-2295-02  
 100 x 25-30 mm 14-2295-03



**WEISSBARTH**  
 21,0 cm, 8 1/4"  
 14-2296-00

Scheidenspekula  
Vaginal Specula  
Espéculos vaginales  
Speculi vaginali

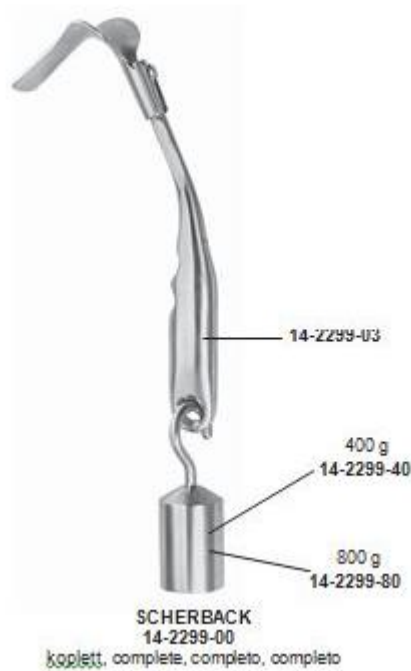

Scheidenspekula  
Vaginal Specula  
Espéculos vaginales  
Speculi vaginali



Satz  
Set  
Juego  
Set

**KRISTELLER**  
Fig. 1 14-2300-01  
Fig. 2 14-2300-02  
Fig. 3 14-2300-03



Spekula allein, flach  
Specula only, flat hollow  
Espéculos suelto, con huecos planos  
Solo speculi, piatta

**KRISTELLER**  
105 x 26 mm 14-2301-01  
105 x 28 mm 14-2301-02  
105 x 33 mm 14-2301-03



Halter allein  
Retractors only  
Valvas suelto  
Solo valve

**KRISTELLER**  
115 x 22 mm 14-2302-01  
115 x 24 mm 14-2302-02  
115 x 29 mm 14-2302-03



Satz  
Set  
Juego  
Set

**KRISTELLER**  
Fig. 1 14-2303-01  
Fig. 2 14-2303-02  
Fig. 3 14-2303-03



Spekula allein, flach  
Specula only, flat hollow  
Espéculos suelto, con huecos planos  
Solo speculi, piatta

**KRISTELLER**  
110 x 27 mm 14-2304-01  
110 x 30 mm 14-2304-02  
110 x 36 mm 14-2304-03



Halter allein  
Retractors only  
Valvas suelto  
Solo valve

**KRISTELLER**  
115 x 23 mm 14-2305-01  
115 x 26 mm 14-2305-02  
115 x 32 mm 14-2305-03

Scheidenspekula  
Vaginal Specula  
Espéculos vaginales  
Speculi vaginali



Satz  
Set  
Juego  
Set

**KRISTELLER**  
Fig. 0 14-2306-00  
Fig. 1 14-2306-01  
Fig. 2 14-2306-02  
Fig. 3 14-2306-03



Spekula allein  
Specula only  
Espéculos sueltos  
Solo speculi

**KRISTELLER**  
70 x 15 mm 14-2307-00  
70 x 21 mm 14-2307-01  
80 x 30 mm 14-2307-02  
90 x 36 mm 14-2307-03



Halter allein  
Retractors only  
Valvas sueltos  
Solo valvae

**KRISTELLER**  
75 x 10 mm 14-2308-00  
75 x 23 mm 14-2308-01  
85 x 26 mm 14-2308-02  
100 x 32 mm 14-2308-03



konisch, für Jungfrauen  
conical blades, for virgins  
valvas conicos, para vírgenes  
valve coniche, per vergini

Satz  
Set  
Juego  
Set

**KRISTELLER**  
Fig. 00 14-2309-01  
Fig. 00 14-2309-02



Spekula allein  
Specula only  
Espéculos sueltos  
Solo speculi

**KRISTELLER**  
105 x 18mm 14-2310-01  
105 x 21 mm 14-2310-02



Halter allein  
Retractors only  
Valvas sueltos  
Solo valvae

**KRISTELLER**  
110 x 14 mm 14-2311-01  
110 x 17 mm 14-2311-02

Scheidenspekula  
Vaginal Specula  
Especulos vaginales  
Speculi vaginali



leicht hohl  
slightly-concave  
leggeremente concavos  
leggeremente concavi

Fig	axb	
1	55 x 35 mm	14-2312-01
2	85 x 35 mm	14-2312-02
3	115 x 35 mm	14-2312-03

1	55 x 45 mm	14-2313-01
2	85 x 45 mm	14-2313-02
3	115 x 45 mm	14-2313-03
4	160 x 45 mm	14-2313-04

1	55 x 60 mm	14-2314-01
2	85 x 60 mm	14-2314-02
3	115 x 60 mm	14-2314-03
4	160 x 60 mm	14-2314-04

**DOYEN**  
23,0 cm, 9"



halb-  
hohl/medium-  
concave semi-  
concavos semi-  
concavi

Fig	axb	
1	55 x 35 mm	14-2315-01
2	85 x 35 mm	14-2315-02
3	115 x 35 mm	14-2315-03

1	55 x 45 mm	14-2316-01
2	85 x 45 mm	14-2316-02
3	115 x 45 mm	14-2316-03

1	55 x 60 mm	14-2317-01
2	85 x 60 mm	14-2317-02
3	115 x 60 mm	14-2317-03

**DOYEN**  
23,0 cm, 9"

Scheidenspekula  
Vaginal Specula  
Especúlos vaginales  
Speculi vaginali



Satz  
Set  
Juego  
Set

**KALLMORGEN**

70 x 40 mm 14-2318-01  
90 x 40 mm 14-2318-02



Spekula allein  
Specula only  
Especulos sueltos  
Solo speculi

**KALLMORGEN**

70 x 40 mm 14-2319-01  
90 x 40 mm 14-2319-02



Halter allein  
Retractors only  
Valvas sueltas  
Solo valvas

**KALLMORGEN**

70 x 40 mm 14-2320-01  
90 x 40 mm 14-2320-02



70 x 15 mm

**KRISTELLER**  
17,0 cm, 6 3/4"  
14-2321-17



75 x 39 mm

**KALLMORGEN**  
17,0 cm, 6 3/4"  
14-2322-17



**JACKSON**  
75 x 38 mm 14-2323-01  
90 x 38 mm 14-2323-02  
100 x 38 mm 14-2323-03

Scheidenspekula  
Vaginal Specula  
Especulos vaginales  
Speculi vaginali  
76 x 25 mm



70 x 22 mm

**BREISKY**  
14,0 cm, 5½"  
14-2324-01

82 x 30 mm



76 x 25 mm

**BREISKY**  
14,0 cm, 5½"  
14-2324-02

95 x 38 mm



82 x 30 mm

**BREISKY**  
17,0 cm, 6¾"  
14-2324-03

102 x 44 mm



95 x 38 mm

**BREISKY**  
17,0 cm, 6¾"  
14-2324-04



Scheidenspekula und -halter  
 Vaginal Specula and Retractors  
 Espéculos y valvas vaginales  
 Speculi e valve vaginali

**SIMSGO**  
 14-1294-00  
 Satz, Set, Juego, Set



70 x 30 mm

65 x 25 mm

**SIMS**  
 12,5 cm, 5"  
 14-2325-01



70 x 35 mm

70 x 30 mm

**SIMS**  
 15,0 cm, 6"  
 14-2325-02



90 x 40 mm

85 x 35 mm

**SIMS**  
 17,5 cm, 7"  
 14-2325-03



Spekula allein  
 Specula only  
 Espéculos suelto  
 Solo speculi

**MATHIEU**  
 100 x 13-23 mm 14-2326-01  
 100 x 16-30 mm 14-2326-02



Halter allein  
 Retractors only  
 Valvas suelto  
 Solo valve

**MATHIEU**  
 100 x 11-21 mm 14-2327-01  
 100 x 14-27 mm 14-2327-02



**LANDAU**  
 100 x 28 mm 14-2328-01  
 100 x 38 mm 14-2328-02

Scheidenspekula  
Vaginal Specula  
Espéculos vaginales  
Speculi vaginali



**BREISKY**

100x20mm	14-2329-20
100x25mm	14-2329-25
100x30mm	14-2329-30
100x35mm	14-2329-35
100 x40mm	14-2329-40
130x20mm	14-2330-20
130x25mm	14-2330-25
130x30mm	14-2330-30
130x35mm	14-2330-35
130 x40mm	14-2330-40
155 x 40 mm	14-2330-40

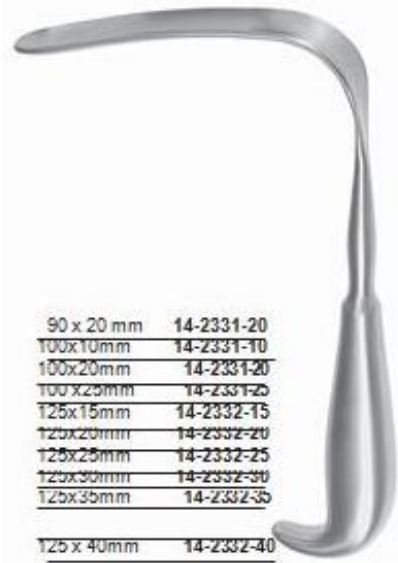

**MATZENAUER**

90 x 20 mm	14-2331-20
100x10mm	14-2331-10
100x20mm	14-2331-20
100 x25mm	14-2331-25
125x15mm	14-2332-15
125x20mm	14-2332-20
125x25mm	14-2332-25
125x30mm	14-2332-30
125x35mm	14-2332-35
125 x 40mm	14-2332-40



**BRAUN MODIE**  
19,0 cm, 7 1/2"  
14-2333-19



**DOYEN**  
23,0 cm, 9"  
14-2333-23



**DOYEN**  
25,0 cm, 9"  
14-2333-25



**WERTHEIM**  
30,0 cm, 12"  
14-2333-30

Endospekula, Lateral-Spekulum,  
 ntrauterinsonde Endospecula, Lateral  
 Speculum, Intrauterine Probe Endoespéculos,  
 Espéculo lateral, Sonda intra-uterina  
 Endospeculi, Speculo lateral, Sonde intrauterine



**KOGAN**  
 24,0 cm, 9 1/2"



**KOGAN**  
 24,0 cm, 9 1/2"



Lateral-Spekulum  
 Lateral speculum  
 t:specula lateral  
 Speculo lateral

25,0 cm, 10"  
 14-2336-25

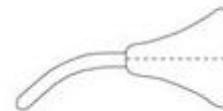

**COHEN**  
 14-2337-01

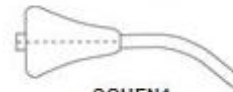

**COHEN1**  
 4-2337-02

**COHEN**  
 14-2337-00

Uterus-Dilatatoren  
 Uterine Dilators  
 Dilataadores uterinos  
 Dilatatori uterini



HEGAR  
 18,5 cm, 7 1/4"

∅ 1,0 mm	14-2338-01
∅ 2,0 mm	14-2338-02
∅ 3,0 mm	14-2338-03
∅ 4,0 mm	14-2338-04
∅ 5,0 mm	14-2338-05
∅ 6,0 mm	14-2338-06
∅ 7,0 mm	14-2338-07
∅ 8,0 mm	14-2338-08
∅ 9,0 mm	14-2338-09
∅ 10,0 mm	14-2338-10
∅ 11,0 mm	14-2338-11
∅ 12,0 mm	14-2338-12
∅ 13,0 mm	14-2338-13
∅ 14,0 mm	14-2338-14
∅ 15,0 mm	14-2338-15
∅ 16,0 mm	14-2338-16
∅ 17,0 mm	14-2338-17
∅ 18,0 mm	14-2338-18
∅ 19,0 mm	14-2338-19
∅ 20,0 mm	14-2338-20
∅ 21,0 mm	14-2338-21
∅ 22,0 mm	14-2338-22
∅ 23,0 mm	14-2338-23
∅ 24,0 mm	14-2338-24
∅ 25,0 mm	14-2338-25
∅ 26,0 mm	14-2338-26



HEGAR  
 18,5 cm, 7 1/4"

∅ 1,5 mm	14-2339-01
∅ 2,5 mm	14-2339-02
∅ 3,5 mm	14-2339-03
∅ 4,5 mm	14-2339-04
∅ 5,5 mm	14-2339-05
∅ 6,5 mm	14-2339-06
∅ 7,5 mm	14-2339-07
∅ 8,5 mm	14-2339-08
∅ 9,5 mm	14-2339-09
∅ 10,5 mm	14-2339-10
∅ 11,5 mm	14-2339-11
∅ 12,5 mm	14-2339-12
∅ 13,5 mm	14-2339-13
∅ 14,5 mm	14-2339-14
∅ 15,5 mm	14-2339-15
∅ 16,5 mm	14-2339-16
∅ 17,5 mm	14-2339-17



205 x 105 x 45 mm

HEGAR  
 14-2340-99  
 Satz, Set, Juego, Set  
 ∅ 1,0 - ∅ 26,0 (26  
 dilators)

HEGAR  
 14-2340-98  
 Satz, Set, Juego, Set  
 ∅ 4,0 - ∅ 17,0  
 (14 dilators)

Uterus-Dilatatore  
 Uterine Dilators  
 Dilatadores uterinos  
 Dilatori uterini



**HEGAR**  
 20,0 cm, 8"

1,0/ 2,0mm	14-2341-01
3,0/ 4,0mm	14-2341-03
5,0/ 6,0mm	14-2341-05
7,0/ 8,0mm	14-2341-07
9,0/10,0mm	14-2341-09
11,0/12,0mm	14-2341-11
13,0/14,0mm	14-2341-13
15,0/16,0mm	14-2341-15
17,0/18,0mm	14-2341-17
19,0/20,0mm	14-2341-19
21,0/22,0mm	14-2341-21
23,0/24,0mm	14-2341-23
25,0 / 26,0mm	14-2341-25



**HEGAR**  
 14-2342-98  
 Satz, Set, Juego, Set  
 Ø 3,0 / 4,0 - Ø 17,0 / 18,0 mm  
 (8 dilators)

**HEGAR**  
 14-2343-99  
 Satz, Set, Juego, Set  
 Ø 1,0 / 2,0 - Ø 25,0 / 26,0 mm  
 (13 dilators)



**HANK**

Ø4,5/ 5,0mm	14-2344-05
Ø5,5/ 6,0mm	14-2344-06
Ø6,5/ 7,0mm	14-2344-07
Ø7,5/ 8,0mm	14-2344-08
Ø8,5/ 9,0mm	14-2344-09
Ø 9,5 10,0 mm	14-2344-10

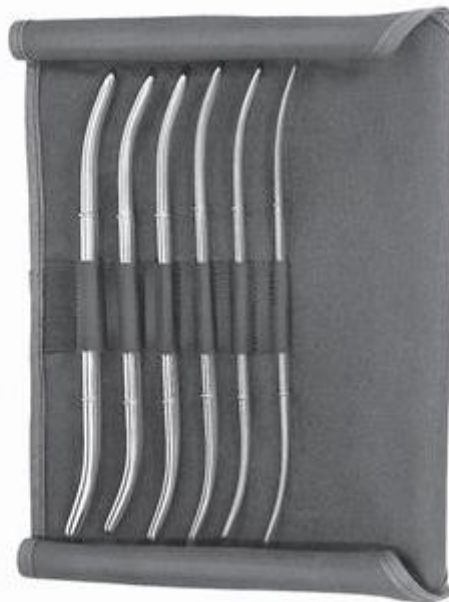

**HANK**  
 14-2345-98  
 Satz, Set, Juego, Set  
 Ø 4,5 / 5,0 - Ø 9,5 / 10,0mm  
 (6 dilators)

Uterus-Dilatatoren, Hakenzangen  
 Uterine Dilators, Uterine Tenaculum Forceps  
 Dilatadores uterinos, Pinzas para coger el cuello del útero  
 Dilatatori uterini, Pinze per abbassare il collo del' utero



PRATT

∅ 4,5/ 5,0mm	14-2346-05
∅ 5,5/ 6,0mm	14-2346-06
∅ 7,5/ 8,0mm	14-2346-08
∅ 8,5/ 9,0mm	14-2346-09
∅ 9,5/10,0mm	14-2346-10
∅11,5/12,0mm	14-2346-12
∅12,5/13,0mm	14-2346-13
∅ 13,5/ 14,0 mm	14-2346-14



PRATT  
 14-2347-98  
 Satz, Set, Juego, Set  
 ∅ 4,5 / 5,0 - ∅ 13,5 / 14,0 mm  
 (8 dilators)



BARRETT  
 18,0 cm, 7"  
 14-2348-18



ADAIR  
 19,0 cm, 7½"  
 14-2349-19



STAUDE-MOORE  
 17,0 cm, 6½"  
 14-2350-17

Hakenzangen  
 Uterine Tenaculum Forceps  
 Pinzas para coger el cuello del útero  
 Pinze per abbassare il collo dell'utero



**JARCHO**  
 20,0 cm, 8"  
 14-2351-20



**SCHROEDER**  
 25,0 cm, 9 1/4"  
 14-2352-25



**BRAUN**  
 25,0 cm, 9 1/4"  
 14-2353-25



**DUPLAY**  
 28,0 cm, 11"  
 14-2354-28



**POZZI**  
 26,0 cm, 10 1/4"  
 14-2355-26



**KAHN**  
 24,0 cm, 9 1/2"  
 14-2356-24

Hakenzangen  
 Uterine Tenaculum Forceps  
 Pinzas para coger el cuello del útero  
 Pinze per abbassare il collo dell'utero



**SKENE**  
 24,0 cm, 9 1/2"  
 14-2357-24



**SCHROEDER**  
 24,0 cm, 9 1/2"  
 14-2358-24



**SCHROEDER**  
 24,0 cm, 9 1/2"  
 14-2359-24



**TEALE**  
 23,0 cm, 9"  
 14-2360-23



**JACOBS**  
 21,0 cm, 8 1/4"  
 14-2361-21



**JACOBS**  
 21,0 cm, 8 1/4"  
 14-2362-21



Hakenzangen  
 Uterine Tenaculum Forceps  
 Pinzas para coger el cuello del útero  
 Pinze per abbassare il collo dell'utero

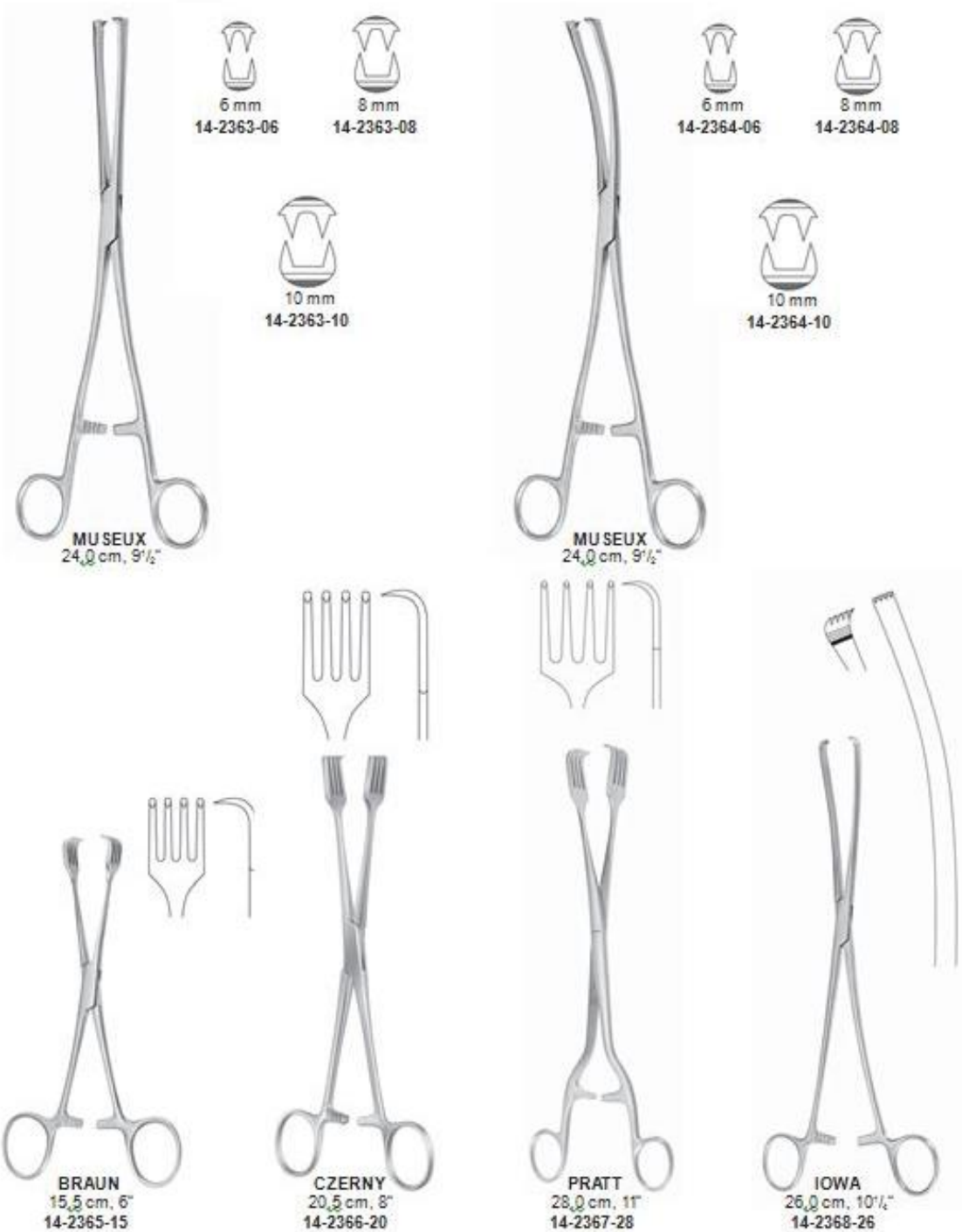

Polypen- und Ovarienzangen, Uterusfaßzangen  
 Polypus and Ovary Forceps, Uterine Elevating Forceps  
 Pinzas para pólipos uterinos y ovarios, Pinzas para la útero  
 Pinze per polipi e ovaie, Pinze per affarrare l'utero



Uterusfaßzangen, Uterussonden,  
Zentimetereinteilung  
Uterine Elevating Forceps, Uterine Probes, graduated in centimeters  
Pinzas para la útero, Histerómetros, graduado en centímetros  
Pinze per afferrare l'utero, Isterometri, graduato in cm



**COLLIN**  
25,0 cm, 9<sup>1</sup>/<sub>4</sub>"  
14-2375-25



**BEACHAM**  
26,0 cm, 10<sup>1</sup>/<sub>4</sub>"  
14-2376-26

Amniotom  
Amniotome  
Amniótomo  
Amniotomo



**BRAUN**  
28,0 cm, 11"  
14-2377-28

Uterus-Depressor  
Uterine depressor  
Depresor uterino  
Depressor uterini



**SIMS**  
32,0 cm, 12<sup>1</sup>/<sub>2</sub>"  
14-2378-32

Ø 4 mm



**SIMS**  
32,0 cm, 12<sup>1</sup>/<sub>2</sub>"  
14-2379-32

Ø 4 mm



**MARTIN**  
32,0 cm, 12<sup>1</sup>/<sub>2</sub>"  
14-2380-32



**BIEGSSAM**  
malleable  
malleable  
malleabile

**MARTIN**  
32,0 cm, 12<sup>1</sup>/<sub>2</sub>"  
14-2381-32



**VALLEIX**  
25,0 cm, 10"  
14-2382-25

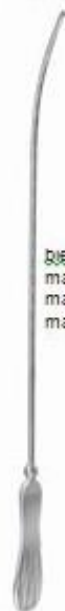

**SIMPSON**  
29,0 cm, 11<sup>1</sup>/<sub>2</sub>"  
14-2383-29

**BIEGSSAM**  
malleable  
malleable  
malleabile



**COLLIN**  
28,0 cm, 11"  
14-2384-28

Biopsieküretten  
Biopsy Curettes  
Curetas para biopsia  
Curette per biopsia



**KEVORKIAN**  
30,0 cm, 12"  
14-2385-30



**KEVORKIAN**  
30,0 cm, 12"  
14-2386-30



**KEVORKIAN**  
30,0 cm, 12"  
14-2387-30



**NOVAK**  
23,0 cm, 9"  
14-2391-04



**RANDALL**  
23,0 cm, 9"  
14-2392-04



**MILAN**  
29,0 cm, 11 1/2"



14-2388-04



14-2389-04



14-2390-04

Myominstrumente  
Myoma Instruments  
Instrumentos para mioma  
Strumenti per fibroma

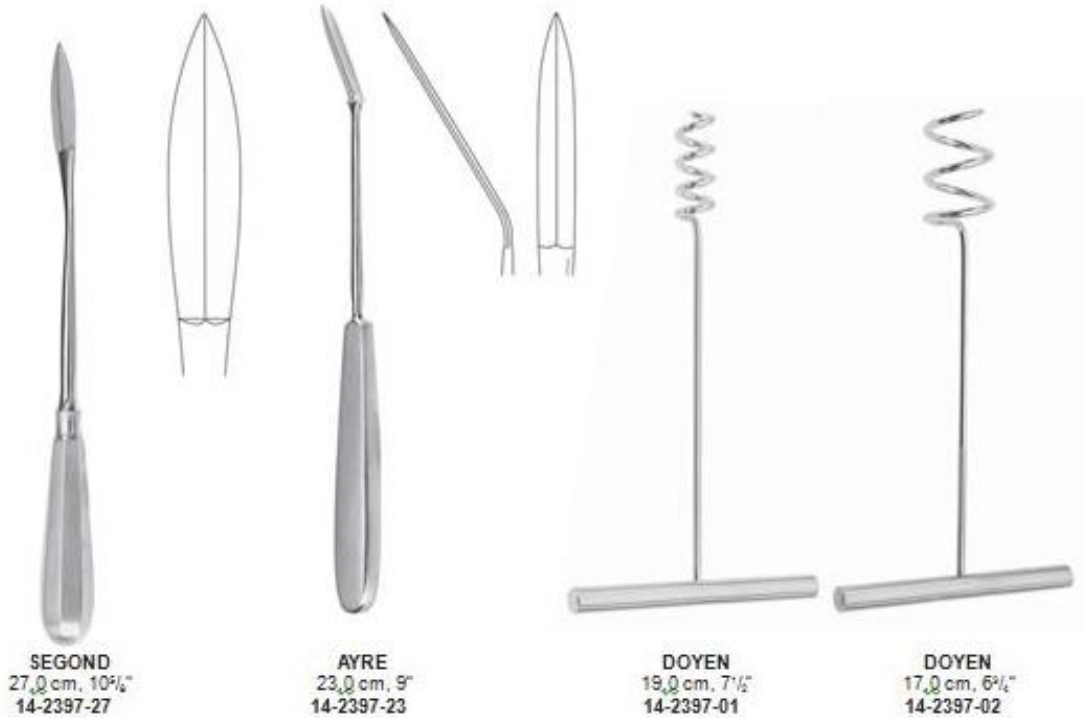
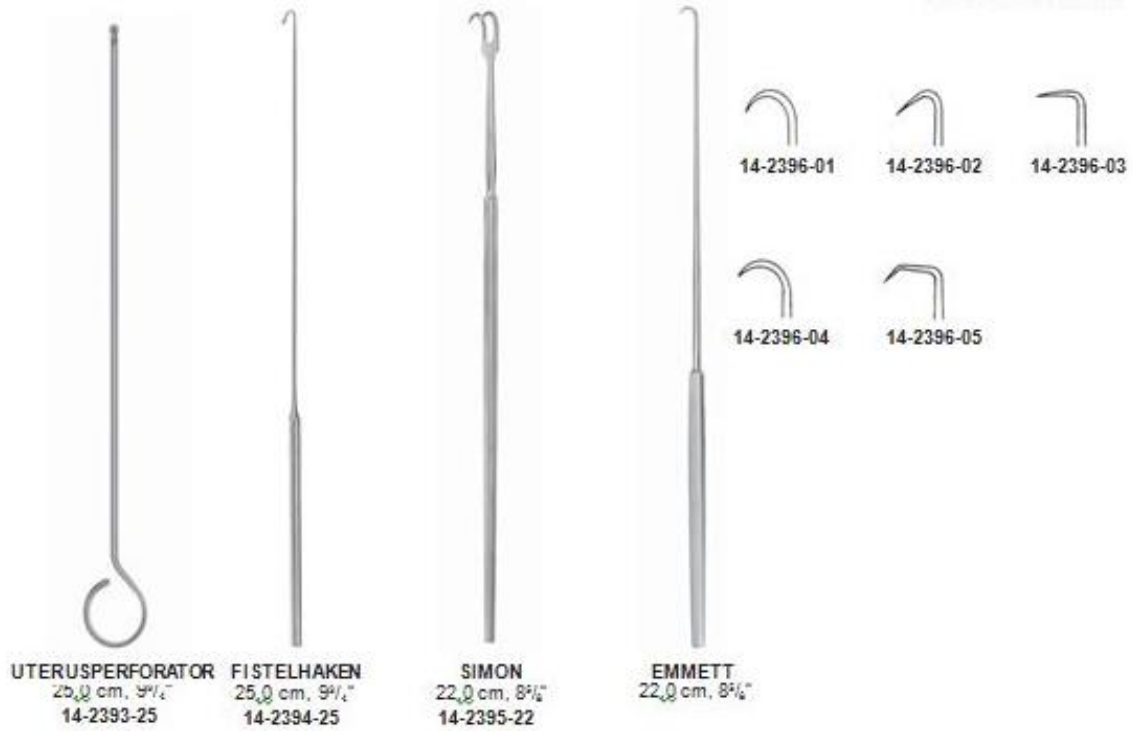

Uterusküretten  
 Uterine Curettes  
 Curetas uterinas  
 Curette uterine



ṡċbaŋ, testsharp,  
 rigid cortantes,  
 rgidas acute,  
 rgide

Fig. 00	14-2398-05
Fig. 0	14-2398-06
Fig. 1	14-2398-07
Fig. 2	14-2398-08
Fig. 3	14-2398-09
Fig. 4	14-2398-11
Fig. 5	14-2398-12
Fig. 6	14-2398-14
Fig. 7	14-2398-15
Fig. 8	14-2398-16
Fig. 9	14-2398-19
Fig. 10	14-2398-20
Fig. 11	14-2398-21
Fig. 12	14-2398-23

RECAMIER  
 26,0 cm, 10 1/4"



ṡċbaŋ, biegsam  
 sharp, malleable  
 cortantes, malleable  
 acute, malleable

Fig. 00	14-2399-05
Fig. 0	14-2399-06
Fig. 1	14-2399-07
Fig. 2	14-2399-08
Fig. 3	14-2399-09
Fig. 4	14-2399-11
Fig. 5	14-2399-12
Fig. 6	14-2399-14
Fig. 7	14-2399-15
Fig. 8	14-2399-16
Fig. 9	14-2399-19
Fig. 10	14-2399-20
Fig. 11	14-2399-21
Fig. 12	14-2399-23

RECAMIER  
 26,0 cm, 10 1/4"

Uterusküretten  
 Uterine Curettes  
 Curetas uterinas  
 Curette uterine



scharf, festsharp,  
 rigid cortantes,  
 rigidas acute,  
 rigide

Fig. 00	14-2400-05
Fig. 0	14-2400-06
Fig. 1	14-2400-07
Fig. 2	14-2400-08
Fig. 3	14-2400-09
Fig. 4	14-2400-11
Fig. 5	14-2400-12
Fig. 6	14-2400-14
Fig. 7	14-2400-15
Fig. 8	14-2400-16
Fig. 9	14-2400-19
Fig. 10	14-2400-20
Fig. 11	14-2400-21
Fig. 12	14-2400-23

**SIMS**

26,0 cm, 10 1/4"



scharf, biegsam  
 sharp, malleable  
 cortantes, maleable  
 acute, maleable

Fig. 00	14-2401-05
Fig. 0	14-2401-06
Fig. 1	14-2401-07
Fig. 2	14-2401-08
Fig. 3	14-2401-09
Fig. 4	14-2401-11
Fig. 5	14-2401-12
Fig. 6	14-2401-14
Fig. 7	14-2401-15
Fig. 8	14-2401-16
Fig. 9	14-2401-19
Fig. 10	14-2401-20
Fig. 11	14-2401-21
Fig. 12	14-2401-23

**SIMS**

26,0 cm, 10 1/4"

Uterusküretten  
 Uterine Curettes  
 Curetas uterinas  
 Curette uterine



scharf, festsharp,  
 rigid cortantes,  
 rigidas acute,  
 rigide

Fig. 00	14-2402-05
Fig. 0	14-2402-06
Fig. 1	14-2402-07
Fig. 2	14-2402-08
Fig. 3	14-2402-09
Fig. 4	14-2402-11
Fig. 5	14-2402-12
Fig. 6	14-2402-14
Fig. 7	14-2402-15
Fig. 8	14-2402-16
Fig. 9	14-2402-19
Fig. 10	14-2402-20
Fig. 11	14-2402-21
Fig. 12	14-2402-23

RECAMIER  
 31,0 cm, 12<sup>1</sup>/<sub>4</sub>"



scharf, biegsam  
 sharp, malleable  
 cortantes, maleable  
 acute, maleabile

Fig. 00	14-2403-05
Fig. 0	14-2403-06
Fig. 1	14-2403-07
Fig. 2	14-2403-08
Fig. 3	14-2403-09
Fig. 4	14-2403-11
Fig. 5	14-2403-12
Fig. 6	14-2403-14
Fig. 7	14-2403-15
Fig. 8	14-2403-16
Fig. 9	14-2403-19
Fig. 10	14-2403-20
Fig. 11	14-2403-21
Fig. 12	14-2403-23

RECAMIER  
 31,0 cm, 12<sup>1</sup>/<sub>4</sub>"



Uterusküretten  
Uterine Curettes  
Curetas uterinas  
Curette uterine



scharf, festsharp,  
rigid cortantes,  
rigidas acute,  
rigide

Fig. 00	14-2404-05
Fig. 0	14-2404-06
Fig. 1	14-2404-07
Fig. 2	14-2404-08
Fig. 3	14-2404-09
Fig. 4	14-2404-11
Fig. 5	14-2404-12
Fig. 6	14-2404-14
Fig. 7	14-2404-15
Fig. 8	14-2404-16
Fig. 9	14-2404-19
Fig. 10	14-2404-20
Fig. 11	14-2404-21
Fig. 12	14-2404-23

SIMS

31,0 cm, 12 1/4"



scharf, biegsam  
sharp, malleable  
cortantes, maleable  
acute, malleable

Fig. 00	14-2405-05
Fig. 0	14-2405-06
Fig. 1	14-2405-07
Fig. 2	14-2405-08
Fig. 3	14-2405-09
Fig. 4	14-2405-11
Fig. 5	14-2405-12
Fig. 6	14-2405-14
Fig. 7	14-2405-15
Fig. 8	14-2405-16
Fig. 9	14-2405-19
Fig. 10	14-2405-20
Fig. 11	14-2405-21
Fig. 12	14-2405-23

SIMS

31,0 cm, 12 1/4"

Uterusküretten  
 Uterine Curettes  
 Curetas uterinas  
 Curette uterine

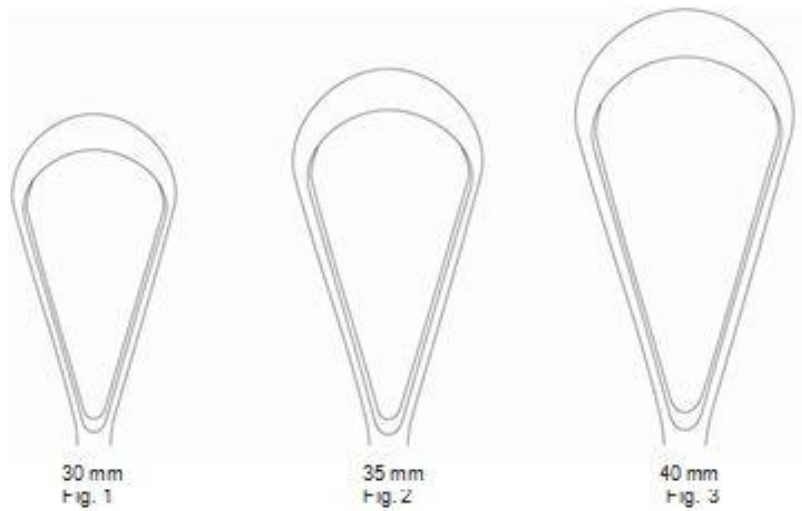

schärf, festsharp,  
 rigid cortantes,  
 rígidas acute,  
 rigide

Fig. 1	14-2406-30
Fig. 2	14-2406-35
Fig. 3	14-2406-40

SIMS

31,0 cm, 12<sup>1</sup>/<sub>4</sub>"



schärf, biegsam  
 sharp, malleable  
 cortantes, maleable  
 acute, malleable

Fig. 1	14-2407-30
Fig. 2	14-2407-35
Fig. 3	14-2407-40

SIMS

31,0 cm, 12<sup>1</sup>/<sub>4</sub>"

Uterusküretten  
 Uterine Curettes  
 Curetas uterinas  
 Curette uterine

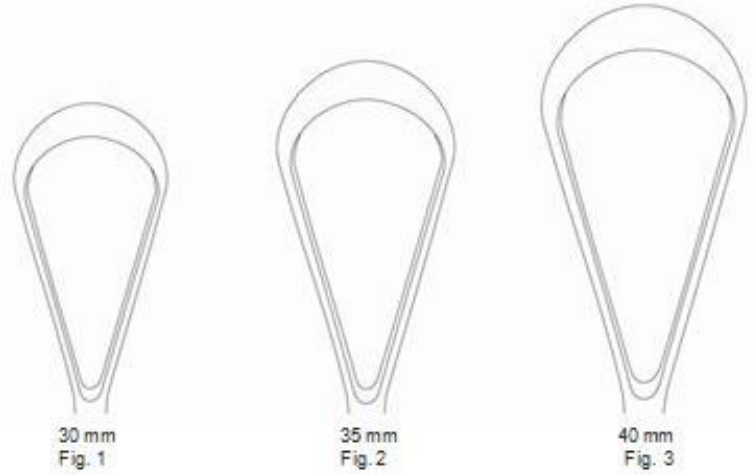

scharf, festsharp,  
 rigid cortantes,  
 rigidas acute,  
 rigide

Fig. 1	14-2408-30
Fig. 2	14-2408-35
Fig. 3	14-2408-40

**BUMM**  
 31,0 cm, 12<sup>1</sup>/<sub>4</sub>"



scharf, biegsam  
 sharp, malleable  
 cortantes, malleable  
 acute, malleabile

Fig. 1	14-2409-30
Fig. 2	14-2409-35
Fig. 3	14-2409-40

**BUMM**  
 31,0 cm, 12<sup>1</sup>/<sub>4</sub>"

Uteruslöffel, Uterus-Biopsiezangen Uterine Scoopes,  
 Cervical Biopsy and Specimen Forceps  
 Cucharillas uterinas, Pinzas saca-bocados para biopsia  
 Curette uterine, Pinze per la biopsia cervicale e da prelievo



**BLAKE**  
 27,0 cm, 10<sup>3</sup>/<sub>8</sub>"  
 14-2411-27



**SIMON**  
 25,0 cm, 9<sup>3</sup>/<sub>8</sub>"



**THOM S-GAYLOR**  
 22,0 cm, 8<sup>3</sup>/<sub>8</sub>" 14-2412-22  
 24,0 cm, 9<sup>1</sup>/<sub>2</sub>" 14-2412-24



**SCHUBERT**  
 21,0 cm, 8<sup>1</sup>/<sub>4</sub>" 14-2413-21  
 29,0 cm, 11<sup>1</sup>/<sub>2</sub>" 14-2413-29



**SCHUMACHER-VANDOREN**  
 24,0 cm, 9<sup>1</sup>/<sub>2</sub>"  
 14-2414-24

Uterus-Biopsiezangen  
 Cervical Biopsy and Specimen Forceps  
 Pinças saca-bocados para biopsia  
 Pinze per la biopsia cervicale e da prelievo



**THOM S-GAYLOR**  
 24,0 cm, 9 1/2"  
 14-2415-24



**FAURE**  
 21,0 cm, 8 1/4"  
 14-2416-21



**SCHUBERT**  
 26,0 cm, 10 1/4"  
 14-2417-26

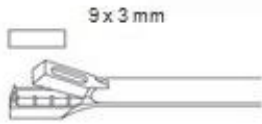
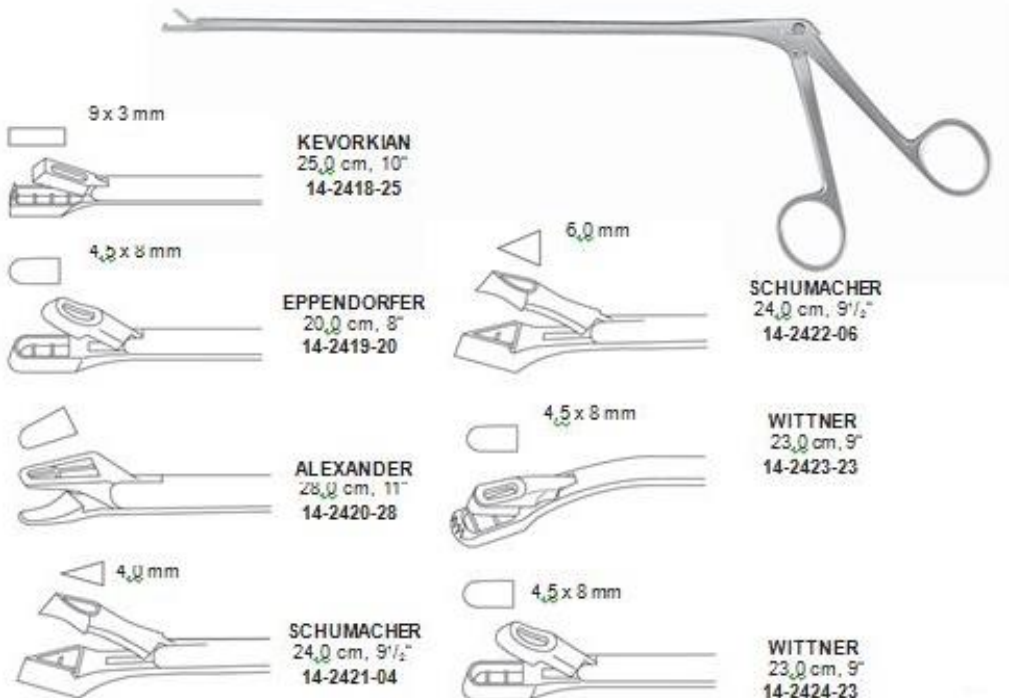

**KEVORKIAN**  
 25,0 cm, 10"  
 14-2418-25

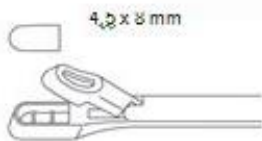

**EPPENDORFER**  
 20,0 cm, 8"  
 14-2419-20

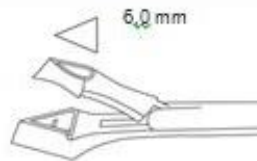

**SCHUMACHER**  
 24,0 cm, 9 1/2"  
 14-2422-06



**ALEXANDER**  
 28,0 cm, 11"  
 14-2420-28

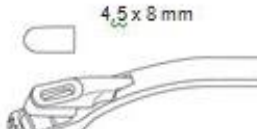

**WITTNER**  
 23,0 cm, 9"  
 14-2423-23

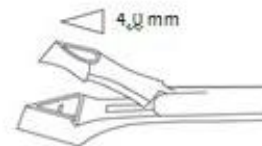

**SCHUMACHER**  
 24,0 cm, 9 1/2"  
 14-2421-04



**WITTNER**  
 23,0 cm, 9"  
 14-2424-23

Uterus-Biopsiezangen  
 Cervical Biopsy and Specimen Forceps  
 Pinzas saca-bocados para biopsia  
 Pinze per la biopsia cervicale e da prelievo

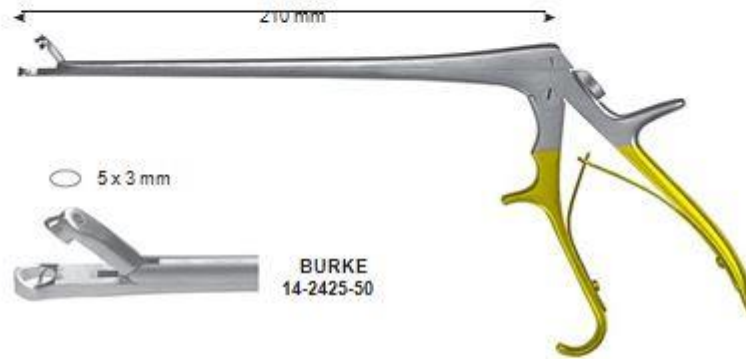

Geburtszangen  
Obstetrical Forceps  
Fórceps para obstétrica  
Forbici per ostetricia



**WRIGLEY**  
28,0 cm, 11"  
14-2431-28



**SIMPSON**  
30,0 cm, 11<sup>3</sup>/<sub>4</sub>"  
14-2432-30



**SIMPSON-BRAUN**  
33,0 cm, 13"  
14-2433-33



**SIMPSON-BRAUN**  
36,0 cm, 14<sup>1</sup>/<sub>4</sub>"  
14-2434-36



**SIMPSON-LUIKART**  
36,0 cm, 14<sup>1</sup>/<sub>4</sub>"  
14-2435-36



**DELEE**  
30,0 cm, 11<sup>3</sup>/<sub>4</sub>"  
14-2436-30



**DELEE**  
36,0 cm, 14<sup>1</sup>/<sub>4</sub>"  
14-2437-36



**DELEE**  
38,0 cm, 15<sup>1</sup>/<sub>4</sub>"  
14-2438-38

Geburtszangen  
 Obstetrical Forceps  
 Fórceps para obstétrica  
 Forbici per ostetricia



**MCLEAN**  
 36,0 cm, 14<sup>1</sup>/<sub>2</sub>"  
 14-2439-36



**KIELAND**  
 41,0 cm, 16"  
 14-2440-41



**KIELAND-LUIKART**  
 40,0 cm, 15<sup>3</sup>/<sub>4</sub>"  
 14-2441-40



**PIPER**  
 44,0 cm, 17<sup>1</sup>/<sub>4</sub>"  
 14-2442-44



**ELLIOT**  
 32,0 cm, 12<sup>1</sup>/<sub>2</sub>"  
 14-2443-32



**ELLIOT**  
 38,0 cm, 15"  
 14-2444-38



**NAEGELE**  
 36,0 cm, 14<sup>1</sup>/<sub>4</sub>"  
 14-2445-36



**NAEGELE**  
 40,0 cm, 15<sup>3</sup>/<sub>4</sub>"  
 14-2446-40





Geburtszangen, Plazentar- und Abortuszangen  
Obstetrical Forceps, Placenta and Ovum Forceps  
Fórceps para obstétrica, Pinças para aborto y placenta  
Forbici per ostetricia, Pinze per placenta e per ovaie



**GREEN-ARMYTAGE**  
21,0 cm, 8<sup>1</sup>/<sub>4</sub>"  
14-2447-21



**PESTALOZZA**  
30,0 cm, 11<sup>3</sup>/<sub>4</sub>"  
14-2448-30

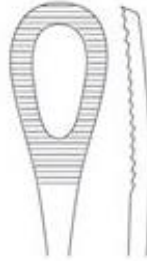

**SAENGER**  
27,0 cm, 10<sup>3</sup>/<sub>4</sub>"  
14-2449-27



**SAENGER**  
27,0 cm, 10<sup>3</sup>/<sub>4</sub>"  
14-2450-27



**WINTER**  
28,0 cm, 11"



Fig. 1  
14-2451-01



Fig. 2  
14-2451-02



Fig. 3  
14-2451-03



Fig. 1  
14-2452-01



Fig. 2  
14-2452-02



Fig. 3  
14-2452-03

Plazentar- und Abortuszangen  
 Placenta and Ovum Forceps  
 Pinzas para aborto y placenta  
 Pinze per placenta e per ovaie



**WALLICH**  
 42,0 cm, 16 1/2"  
 14-2453-42



**MARTIN**  
 34,0 cm, 13 3/4"  
 14-2454-34



**BIERER**  
 33,0 cm, 13"  
 14-2455-01



**BIERER**  
 33,0 cm, 13"  
 14-2456-02



**BIERER**  
 33,0 cm, 13"  
 14-2457-01



**BIERER**  
 33,0 cm, 13"  
 14-2458-02

Hautstanzen, Nagel Instrumente  
 Dermal Punches, Nail Instruments  
 Trépanos cutáneos, Instrumentos para uñas  
 Trapani dermatici, Strumenti per unghie



**PIFFARD**  
 14,0 cm, 5<sup>3</sup>/<sub>4</sub>"

Lupusküretten  
 Lupus curettes  
 Curetas para lupus  
 Raschiatoio per lupus



**KEYES**  
 12,0 cm, 4<sup>3</sup>/<sub>4</sub>"



**KEYES**  
 12,0 cm, 4<sup>3</sup>/<sub>4</sub>"  
 14-2461-00

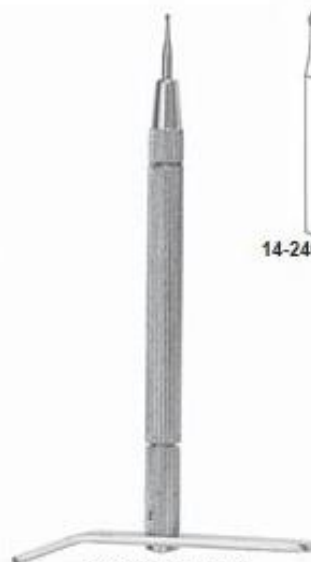

**NAGELBOHRER**  
 14-2462-00  
 komplett, complete,  
 completo, completo



Komedonenquetscher  
Comedo Extractors  
Saca-comedones  
Tiracomedoni



**UNNA**  
14,0 cm, 5 1/4"  
14-2463-14



**UNNA**  
14,0 cm, 5 1/4"  
14-2464-14



**SAALFELD**  
10,0 cm, 4"  
14-2465-10



**SAALFELD**  
14,0 cm, 5 1/4"  
14-2466-14



**SCHAMBERG**  
10,0 cm, 4"  
14-2467-10



**WALTON**  
14,0 cm, 5 1/4"  
14-2468-14



**FOX**  
14,0 cm, 5 1/4"



3 mm  
14-1100-03



4 mm  
14-11100-04



5 mm  
14-2469-05



6 mm  
14-2469-06

Lupusküretten  
Lupus curettes  
Curetas para lupus  
Raschiatoio per lupus



Nagel Instrumente  
Nail Instruments  
Instrumentos para uñas  
Strumenti per unghie



059-1420-01

**FINGERRING SÄGE**  
17,0 cm, 6 1/4"  
14-2470-17



059-1430-01

**WALTON**  
16,0 cm, 6 1/4"  
14-2471-16



**RADOLF**  
13,5 cm, 5 1/4"  
14-2472-13



**NAGELZANGE**  
13,5 cm, 5 1/4"  
14-2473-13



**NAGELZANGE**  
13,0 cm, 5"  
14-2474-13

































14-2475-00

14-2475-01

**NAGELZANGE**  
14,0 cm, 5 1/2"

Scharfe Löffel  
 Bone Currettes  
 Cucharillas cortantes  
 Curetta per ossa

		
	Fig. 0000 14-2477-04	Fig. 0000 14-2478-04
		
	Fig. 000 14-2477-03	Fig. 000 14-2478-03
		
Fig. 000 14-2476-03	Fig. 00 14-2477-02	Fig. 00 14-2478-02
		
Fig. 00 14-2476-02	Fig. 0 14-2477-01	Fig. 0 14-2478-01
		
Fig. 0 14-2476-01	Fig. 1 14-2477-11	Fig. 1 14-2478-11
		
Fig. 1 14-2476-11	Fig. 2 14-2477-12	Fig. 2 14-2478-12
		
Fig. 1 14-2476-11	Fig. 3 14-2477-13	Fig. 3 14-2478-13
		
Fig. 2 14-2476-12	Fig. 4 14-2477-14	Fig. 4 14-2478-14
		
Fig. 3 14-2476-13	Fig. 5 14-2477-15	Fig. 5 14-2478-15
		
Fig. 4 14-2476-14	Fig. 6 14-2477-16	Fig. 6 14-2478-16
		
<b>SCHEDÉ</b> 17,0 cm, 6½"	<b>VOLKMANN</b> 17,0 cm, 6½"	<b>BRUNS</b> 17,0 cm, 6½"

Scharfe Löffel  
Bone Curettes  
Cucharillas cortantes  
Curetta per ossa

Fig. 00000  
14-2479-04

Fig. 0000  
14-2479-03

Fig. 000  
14-2479-02

Fig. 00  
14-2479-01

Fig. 0  
14-2479-00

**LEMPERT**  
21,5 cm, 8½"

Fig. 00  
14-2480-02

Fig. 0  
14-2480-01

Fig. 1  
14-2480-11

**HALLE**  
21,0 cm, 8¼"

Fig. 00  
14-2481-02

Fig. 0  
14-2481-01

Fig. 1  
14-2481-11

Fig. 2  
14-2481-12

**DAUBEN SPECK**  
20,0 cm, 8"



Scharfe Löffel  
Bone Currettes  
Cucharillas cortantes  
Curetta per ossa



Fig. 1  
14-2482-11



Fig. 2  
14-2482-12

**WILLIGER**  
17,0 cm, 6<sup>3</sup>/<sub>4</sub>"



Fig. 0  
14-2483-00



Fig. 1  
14-2483-01



Fig. 2  
14-2483-02

**WILLIGER**  
14,0 cm, 5<sup>1</sup>/<sub>2</sub>"



Fig. 00/0  
14-2485-00  
14,0 cm, 5<sup>1</sup>/<sub>2</sub>"



Fig. 0/1  
14-2485-01  
14,0 cm, 5<sup>1</sup>/<sub>2</sub>"



Fig. 1/2  
14-2485-12  
14,0 cm, 5<sup>1</sup>/<sub>2</sub>"

**MARTINI**  
14,0 cm, 5<sup>1</sup>/<sub>2</sub>"  
14-2485-00



14-2486-13  
13,0 cm, 5"

14-2486-14  
14,0 cm, 5<sup>1</sup>/<sub>2</sub>"

14-2486-17  
17,0 cm, 6<sup>3</sup>/<sub>4</sub>"

**VOLKMANN**



**JAN SEN**  
15,0 cm, 6"  
14-2487-15



**JAN SEN**  
16,0 cm, 6<sup>1</sup>/<sub>4</sub>"  
14-2487-16



Dissektoren, Elevatorien  
Dissectors, Elevators  
Disecadores, Elevadores  
Dissettori, Elevatori

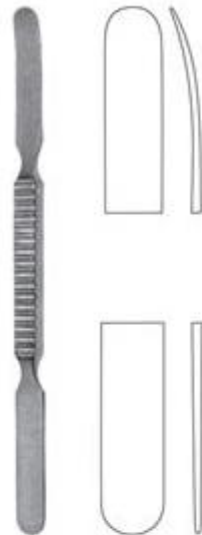

**WAT SON-CHEYNE**  
17,5 cm, 6 7/8"  
14-2488-17



**MCDONALD**  
19,0 cm, 7 1/2"  
14-2488-19



**WILLIGER**  
17,0 cm, 6 1/2"  
14-2492-17



**WILLIGER**  
16,0 cm, 6 1/4"  
14-2489-16



**LANGENBECK**  
20,0 cm, 8"  
14-2490-08



**LANGENBECK**  
20,0 cm, 8"  
14-2491-10