

A	
Abdominal Retractor	183-195
Amputation Knives	5
Amputation Knives, Post Mortem Knives	6-7
Anoscopes, Proctoscopes	228
B	
Bandage and Cloth Scissors, Plaster-of-Paris Shears	39-40
Bladder Retractors	212
Blopsy Curettes	251
Bone Curettes	269-271
Bronchus Forceps	106-107
Bulldog Clamps	83-85
C	
Catheters, Penis Clamp	215
Cervical Biopsy and Specimen Forceps	259-261
Chisels, Gouges, Osteotomies	275-277
Comedo Extractors	267
Common Bile Duct Dilators	210-211
Cotton Applicators	199
D	
Dermal Punches, Nail Instruments	266
Dissecting and Ligature Forceps	97-104
Dissecting Forceps	57-61
Dissecting Scissors	11-20
Dissecting Scissors with tungsten carbide edges	43-46
Dissecting Scissors, fine surgical scissors	21
Dissectors, Elevator's	272
Dura and Skin Retractors	144-145
E	
Enterotomy Scissors	36
Episiotomy Scissors, Umbilical Cord Scissors	37-38
F	
Fine Surgical Scissors	22-26
Forceps with tungsten carbide inserts	75-76
G	
Gall Duct and Kidney pedicle Clamps	105-106
Gall Stone Forceps	207-210
Gynecology scissors	34-36
Gynecology Scissors with tungsten carbide edge	47

H	
Haemorrhoidal Forceps, Fistula Probes	230
Hemostatic Forceps	87-96
Hysterectomy Forceps	107-111
I	
Intestinal and Stomach Clamp Forceps	224
Intestinal and Stomach Clamps	223
Intestinal and Tissue Grasping Forceps	86
Intestinal and Tissue Grasping Forceps	216-218
Intestinal and Tissue Grasping Forceps Clamps Bulldog	85
Intestinal Clamp Forceps	219-222
J	
Jeweler's Forceps, Vessel Dilators	73
K	
Kidney Stone Forceps	207
Knives	3-4
L	
Lateral Speculum, Intrauterine Probe Endoespeculos	242
Ligature Needle	134-141
Ligature Scissors	28-29
Lobectomy Scissors, Episiotomy Scissors	37
M	
Mallets	277
Micro Adventitia Scissors	56
Micro Dissecting Scissors	55
Micro Forceps	71-72
Micro Needle Holders	118-120
Micro Scissors	54-55
Myoma Instruments	252
N	
Nail Instruments	268
Needle Holders	112-118
Needle Holders with tungsten Carbide Inserts	121-132
Neurosurgical Scissors, Tonsil Scissors, Nasal Scissors	29-30
O	
Obstetrical Forceps	262-263
Obstetrical Forceps, Placenta and Ovum Forceps	264
P	
Peritoneum Forceps, Hysterectomy Forceps	107-108
Placenta and Ovum Forceps	264-265
Polypus and Ovum Forceps, Uterine Elevating Forceps	249

Probes	197-198
Prostatectomy Instruments	213
Prostatic Retractors, Bladder Retractor	214
Q	
R	
Raspatories	273-274
Rectal Blosy Forceps	229
Rectal Retractor, Sphincter scopes	227
Rectal Specula	226
Resection Knives	8
Retractors	146-172
Reverdin Needles	133
Rib Spreaders	196
S	
Scalpel Blades, Scalpel Handles	1-2
Scissors with tungsten carbide edges	50
Self-Retaining Retractors	173-182
Self-Retaining Retractors, Abdominal Retractors	183-185
Sigmoid Anastomosis Forceps	225
Splinter Forceps	70-71
Sponge and Dressing Forceps	79-81
Sterilizing Forceps	278
Straightening Plate	7
Suction Tubes	204-206
Super-Cut Scissors	51-53
Surgical Scissors	9
Surgical Scissors	27-28
Surgical Scissors , Dissecting Scissors	10
Surgical Scissors with tungsten carbide edges	41-42
Suture Instruments	142-143
T	
Tissue Forceps	62-69
Tonsil Scissors, Nasal Scissors, Vascular Scissors	30-31
Towel Clamps	77-79
Trays	279-280
Trocars	201-204
Tubing Clamps	82
U	
Uterine Curettes	253-258
Uterine Dilators	243-245
Uterine Elevating Forceps, Uterine Probes, Graduated in Centimeters	250
Uterine Tenaculum Forceps	245-248
V	

Vascular Scissors	31-34
Vascular Scissors with tungsten carbide edges	48-49
Vaginal Specula	231-241
Vaginal Specula and Retractors	240
Varicose Vein Probe Set	200
Vessel Dilators, A traumatic Forceps	73-74
W	
Wire Scissors, Bandage and Cloth Scissors	39
X	
Y	
Z	

Sterile Skalpellklingen, Skalpellgriffe Sterile
Scalpel Blades, Scalpel Handles
Hojas de bisturíes estériles, Mangos de bisturíes
Lame per bisturi sterili, Manici per bisturi



No. 3
13,0 cm, 5°
14-1003-03



No. 313
13,0 cm, 5°
14-1003-04



No. 3L
21,0 cm, 8 1/2°
14-1003-05



No. 716
6,5 cm, 6 1/2°
14-1007-06



No. 7K13
13,0 cm, 5°
14-1007-07



Sterile Skalpelli, Skalpellgriffe Sterile Scalpel Blades, Scalpel Handles Hojas de bisturíes estériles, Mangos de bisturíes Lame per bisturi sterili, Manici per bisturi



No.
413,5 cm, 5 $\frac{1}{2}$ "
14-1004-04



No.
4L 21,0 cm, 8 $\frac{1}{2}$ "
14-1004-04L



No.
813,5 Cm, 5 $\frac{1}{2}$ "
14-1004-08



No.
914,5 cm, 5 $\frac{3}{4}$ "
14-1004-09

Skalpelle
Knives
Bisturies
Bisturi



Fig.1	14-1006-01
Fig.2	14-1006-02
Fig.3	14-1006-03



OPERATION
17,0 cm, 6¼"



Fig.10	14-1006-10
Fig.12	14-1006-12
Fig.14	14-1006-14
Fig.16	14-1006-16
Fig.18	14-1006-18



COLLIN
16,0 cm, 6¼"



Fig.4	14-1006-04
Fig.5	14-1006-05
Fig.6	14-1006-06

Skalpelle
Knives
Bisturies
Bisturi



Fig.1 14-1007-01
Fig.2 14-1007-02
Fig.3 14-1007-03
Fig.4 14-1007-04
Fig.5 14-1007-05



Fig.1 14-1008-01
Fig.2 14-1008-02
Fig.3 14-1008-03
Fig.4 14-1008-04
Fig.5 14-1008-05



Fig. 15
14-1008-15



DISSECTING
17,0 cm, 6¼"



Fig.6 14-1007-06
Fig.7 14-1007-07
Fig.8 14-1007-08
Fig.9 14-1007-09
Fig. 10 14-1007-10



DIEFENBACH
16,0 cm, 6¼"



Fig.6 14-1008-06
Fig.7 14-1008-07
Fig.8 14-1008-08
Fig.9 14-1008-09



Fig. 16
14-1008-16



Amputationsmesser
Amputation Knives
Cuchillos para amputación
Coltelli per amputazione



COLLI

A	
13,0 cm, 5"	14-1008-13
16,0 cm, 6 1/2"	14-1008-16
19,0 cm, 7 1/2"	14-1008-19
22,0 cm, 8 3/4"	14-1008-22
28,0 cm, 11"	14-1008-28



CATLIN

A	
16,0 cm, 6 1/2"	14-1009-16
19,0 cm, 7 1/2"	14-1009-19
22,0 cm, 8 3/4"	14-1009-22

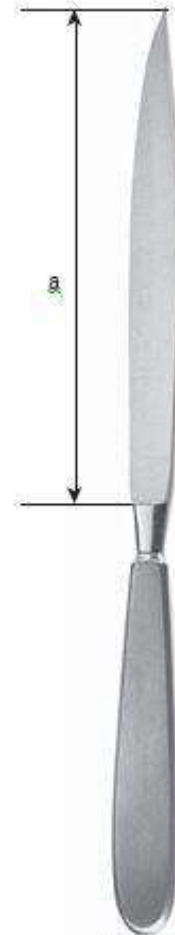

LISTON

A	
17,0 cm, 6 3/4"	14-1009-17
20,0 cm, 8"	14-1009-20
22,0 cm, 8 3/4"	14-1009-22

Amputationsmesser, Messer für Autopsie
 Amputation Knives, Post Mortem Knives
 Cuchillos para amputación, Cuchillos para autopsia
 Coltelli per amputazione, Coltelli per autopsia



LANGENBECK
 14-1010-16

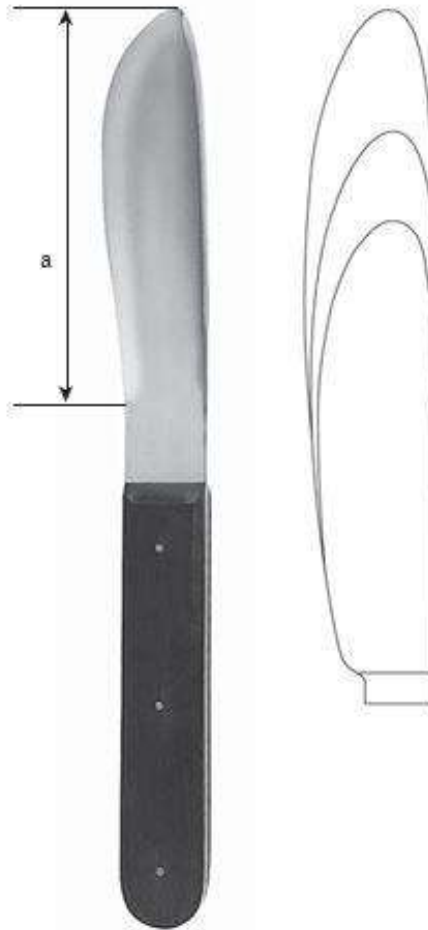

WALB

A	
11,0 cm, 4 1/2"	14-1010-11
14,0 cm, 5 1/2"	14-1010-14
17,0 cm, 6 3/4"	14-1010-17

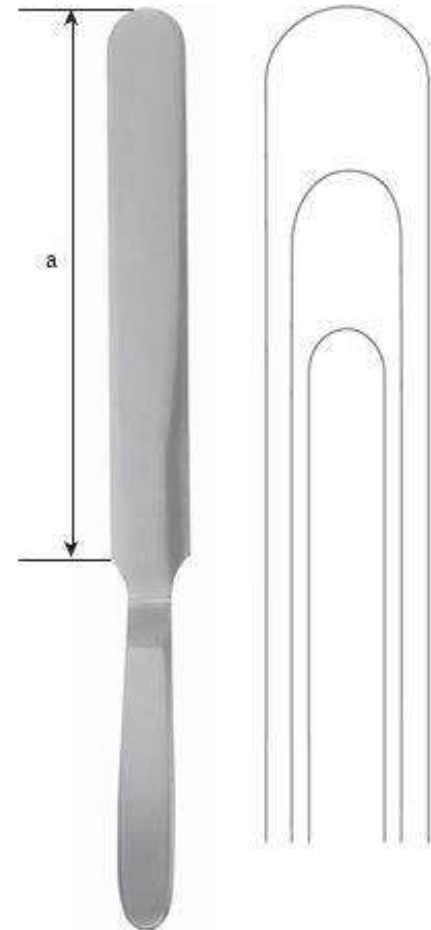

VIRCHOW

A	
16,0 cm, 6 1/2"	14-1011-16
20,0 cm, 8"	14-1011-20
24,0 cm, 9 1/2"	14-1011-24



Amputationsmesser, Dermatome
Amputation Knives, Dermatomes
Cuchillos para amputación, Dermátomos
Coltelli per amputazione, Dermatomi



LANGENBECK
18,0 cm, 7"
14-1011-55



CARTILAGE
17,5 cm, 6⁷/₈"
14-1011-65

mit Schaber
with raspatory
con periostótomo
con raschiatoio

Haut-SpannplattenSkin
straightening plate
Placa para extender la piel
Placca per stendere la pelle



14-1011-30



Resektionsmesser
Resection Knives
Cuchillos para resección
Coltelli per resezione

14-1012-19
Ersatzklinge
Spare blade
Hoja de repuesto
Lama di ricambio



SILVER
19 cm, 7 1/2"
14-1013-19

14-1012-30
Ersatzklinge
Spare blade
Hoja de repuesto
Lama di ricambio



BRAITHWAITE
30,0 cm, 12"
14-1013-30

14-1012-35
Ersatzklinge
Spare blade
Hoja de repuesto
Lama di ricambio



HUMBY
35,0 cm, 14"
14-1013-35

14-1012-30
Ersatzklinge
Spare blade
Hoja de repuesto
Lama di ricambio



SCHINK
30,0 cm, 12"
14-1013-30



C chirurgische Scheren
Surgical Scissors
Tijeras para cirugía
Forbici per chirurgia



STANDARD	
10,5 cm, 4 1/2°	14-1014-10
11,5 cm, 4 1/2°	14-1014-11
13,0 cm, 5°	14-1014-13
14,5 cm, 5 1/2°	14-1014-14
15,5 cm, 6°	14-1014-15
16,5 cm, 6 1/2°	14-1014-16
17,5 cm, 6 3/4°	14-1014-17
18,5 cm, 7 1/4°	14-1014-18
20,0 cm, 8°	14-1014-20



STANDARD	
10,5 cm, 4 1/2°	14-1015-10
11,5 cm, 4 1/2°	14-1015-11
13,0 cm, 5°	14-1015-13
14,5 cm, 5 1/2°	14-1015-14
15,5 cm, 6°	14-1015-15
16,5 cm, 6 1/2°	14-1015-16
17,5 cm, 6 3/4°	14-1015-17
18,5 cm, 7 1/4°	14-1015-18
20,0 cm, 8°	14-1015-20



STANDARD	
10,5 cm, 4 1/2°	14-1016-10
11,5 cm, 4 1/2°	14-1016-11
13,0 cm, 5°	14-1016-13
14,5 cm, 5 1/2°	14-1016-14
15,5 cm, 6°	14-1016-15
16,5 cm, 6 1/2°	14-1016-16
17,5 cm, 6 3/4°	14-1016-17
18,5 cm, 7 1/4°	14-1016-18
20,0 cm, 8°	14-1016-20



STANDARD	
10,5 cm, 4 1/2°	14-1017-10
11,5 cm, 4 1/2°	14-1017-11
13,0 cm, 5°	14-1017-13
14,5 cm, 5 1/2°	14-1017-14
15,5 cm, 6°	14-1017-15
16,5 cm, 6 1/2°	14-1017-16
17,5 cm, 6 3/4°	14-1017-17
18,5 cm, 7 1/4°	14-1017-18
20,0 cm, 8°	14-1017-20



Chirurgische Scheren,
Präparierscheren Surgical Scissors,
Dissecting Scissors Tijeras para cirugía,
Tijeras de disección Forbici per chirurgia,
Forbici per dissezione



STANDARD	
10,5 cm, 4 1/2"	14-1018-10
11,5 cm, 4 1/2"	14-1018-11
13,0 cm, 5"	14-1018-13
14,5 cm, 5 1/2"	14-1018-14
15,5 cm, 6"	14-1018-15
16,5 cm, 6 1/2"	14-1018-16
17,5 cm, 6 3/4"	14-1018-17
18,5 cm, 7 1/2"	14-1018-18
20,0 cm, 8"	14-1018-20



STANDARD	
10,5 cm, 4 1/2"	14-1020-10
11,5 cm, 4 1/2"	14-1020-11
13,0 cm, 5"	14-1020-13
14,5 cm, 5 1/2"	14-1020-14
15,5 cm, 6"	14-1020-15
16,5 cm, 6 1/2"	14-1020-16
17,5 cm, 6 3/4"	14-1020-17
18,5 cm, 7 1/2"	14-1020-18
20,0 cm, 8"	14-1020-20



DEAVER	
12,0 cm, 4 1/2"	14-1021-12
13,0 cm, 5"	14-1021-13
14,5 cm, 5 1/2"	14-1021-14



DEAVER	
12,0 cm, 4 1/2"	14-1022-12
13,0 cm, 5"	14-1022-13
14,5 cm, 5 1/2"	14-1022-14



Präparierscheren
 Dissecting Scissors
 Tijeras de disección
 Forbici per dissezione



DEAVER	
12,0 cm, 4 ³ / ₄ "	14-1023-12
13,0 cm, 5"	14-1023-13
14,5 cm, 5 ⁷ / ₁₆ "	14-1023-14



DEAVER	
12,0 cm, 4 ³ / ₄ "	14-1024-12
13,0 cm, 5"	14-1024-13
14,5 cm, 5 ⁷ / ₁₆ "	14-1024-14



DEAVER	
12,0 cm, 4 ³ / ₄ "	14-1025-12
13,0 cm, 5"	14-1025-13
14,5 cm, 5 ⁷ / ₁₆ "	14-1025-14



DEAVER	
12,0 cm, 4 ³ / ₄ "	14-1026-12
13,0 cm, 5"	14-1026-13
14,5 cm, 5 ⁷ / ₁₆ "	14-1026-14

Präparierscheren
Dissecting Scissors
Tijeras de disección
Forbici per dissezione



GRAZIL
13,0 cm, 5" 14-1027-13
14,5 cm, 5 7/8" 14-1027-14



GRAZIL
13,0 cm, 5" 14-1028-13
14,5 cm, 5 7/8" 14-1028-14



GRAZIL
13,0 cm, 5" 14-1029-13
14,5 cm, 5 7/8" 14-1029-14



GRAZIL
13,0 cm, 5" 14-1030-13
14,5 cm, 5 7/8" 14-1030-14



Präparierscheren
Dissecting Scissors
Tijeras de disección
Forbici per dissezione



MAYO-STILE

15,0 cm, 6°	14-1035-15
17,0 cm, 6¾°	14-1035-17
19,5 cm, 7¾°	14-1035-19
21,0 cm, 8¾°	14-1035-21



MAYO-STILE

15,0 cm, 6°	14-1036-15
17,0 cm, 6¾°	14-1036-17
19,5 cm, 7¾°	14-1036-19
21,0 cm, 8¾°	14-1036-21



14-1037-17



14-1038-17

MAYO-NOBLE

17,0 cm, 6¾°



FOMON

13,5 cm, 5¾° 14-1039-13

Präparierscheren
Dissecting Scissors
Tijeras de disección
Forbici per dissezione



MAYO-STILE	
15,0 cm, 6°	14-1035-15
17,0 cm, 6 ³ / ₄ °	14-1035-17
19,5 cm, 7 ³ / ₄ °	14-1035-19
21,0 cm, 8 ¹ / ₄ °	14-1035-21



MAYO-STILE	
15,0 cm, 6°	14-1036-15
17,0 cm, 6 ³ / ₄ °	14-1036-17
19,5 cm, 7 ³ / ₄ °	14-1036-19
21,0 cm, 8 ¹ / ₄ °	14-1036-21



MAYO-NOBLE
17,0 cm, 6³/₄°



FOMON
13,5 cm, 5³/₄° 14-1039-13

Präparierscheren
 Dissecting Scissors
 Tijeras De Disección
 Forbici per dissezione



Präparierscheren
Dissecting Scissors
Tijeras de disección
Forbici per dissezione



METZENBAUM

18,0 cm, 7"	14-1046-18
20,0 cm, 8"	14-1046-20
23,0 cm, 9"	14-1046-23
25,0 cm, 10"	14-1046-25
28,0 cm, 11"	14-1046-28
30,0 cm, 12"	14-1046-30



METZENBAUM

18,0 cm, 7"	14-1047-18
20,0 cm, 8"	14-1047-20
23,0 cm, 9"	14-1047-23
25,0 cm, 10"	14-1047-25
28,0 cm, 11"	14-1047-28
30,0 cm, 12"	14-1047-30



ETZENBAUM

18,0 cm, 7"	14-1048-18
20,0 cm, 8"	14-1048-20
23,0 cm, 9"	14-1048-23
25,0 cm, 10"	14-1048-25
28,0 cm, 11"	14-1048-28
30,0 cm, 12"	14-1048-30



METZENBAUM

18,0 cm, 7"	14-1049-18
20,0 cm, 8"	14-1049-20
23,0 cm, 9"	14-1049-23
25,0 cm, 10"	14-1049-25
28,0 cm, 11"	14-1049-28
30,0 cm, 12"	14-1049-30

Präparierscheren
 Dissecting Scissors
 Tijeras de disección
 Forbici per dissezione



Präparierscheren
Dissecting Scissors
Tijeras de disección
Forbici per dissezione

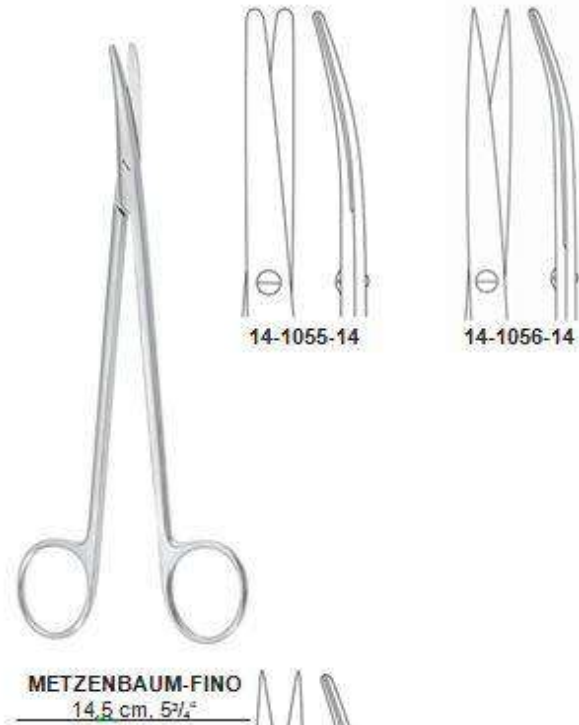



Präparierscheren
Dissecting Scissors
Tijeras de disección
Forbici per dissezione



METZENBAUM-FINOS

18,0 cm, 7"	14-1060-18
20,0 cm, 8"	14-1060-20
23,0 cm, 9"	14-1060-23

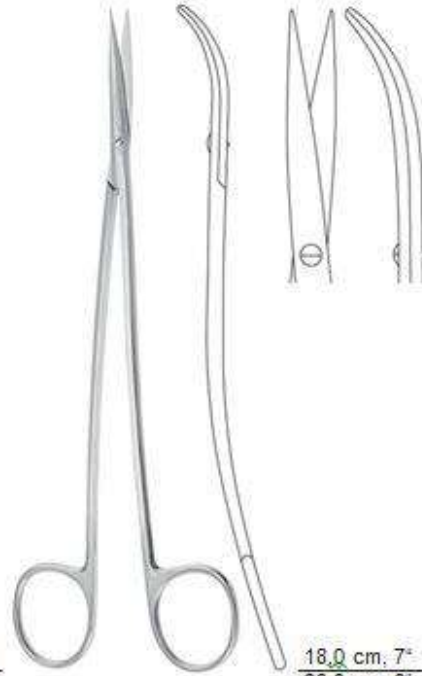

METZENBAUM-FINOS

18,0 cm, 7"	14-1061-18
20,0 cm, 8"	14-1061-20
23,0 cm, 9"	14-1061-23



METZENBAUM-LAHEY
14.0 cm. 5 1/2" 14-1062-14



TOENNIS-ADSON
17.0 cm. 6 3/4" 14-1063-17

Präparierscheren
Dissecting Scissors
Tijeras de disección
Forbici per dissezione





Präparierscheren, feine chirurgische Scheren
 Dissecting Scissors, fine surgical scissors
 Tijeras de disección, tijeras finas para cirugía
 Forbici per dissezione, forbici fine per chirurgia



KILNER(RAGNELL)

12,0 cm, 4 1/4"	14-1070-12
15,0 cm, 6"	14-1070-15
18,0 cm, 7"	14-1070-18
20,0 cm, 8"	14-1070-20



KILNER(RAGNELL)

12,0 cm, 4 1/4"	14-1071-12
15,0 cm, 6"	14-1071-15
18,0 cm, 7"	14-1071-18
20,0 cm, 8"	14-1071-20



REYNOLDS

15,0 cm, 6"	14-1072-15
18,0 cm, 7"	14-1072-18



REYNOLDS

15,0 cm, 6"	14-1073-15
18,0 cm, 7"	14-1073-18
20,0 cm, 8"	14-1073-20
23,0 cm, 9"	14-1073-23
25,0 cm, 10"	14-1073-25

Feine chirurgische Scheren
 Fine surgical scissors
 Tijeras finas para cirugía
 Forbici fine per chirurgia



19,0 cm, 7½"
 14-1074-19

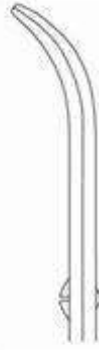

25,0 cm, 10"
 14-1075-25



14-1076-15



14-1077-15



Nerv-Präparierscheren
 Nerve dissecting scissors
 Tijeras para nervios
 Forbici per dissezione di nervi

THOREK



SANVENERO
 14,0 cm, 5½"

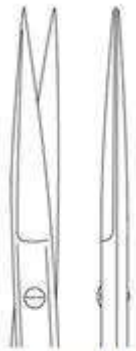

14-1078-14

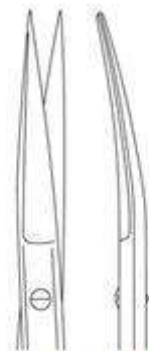

14-1079-14

15,0 cm, 6"



JOSEPH
 14,0 cm, 5½"



14-1080-14

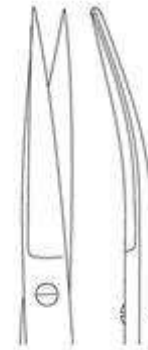

14-1081-14

Feine chirurgische Scheren
 Fine surgical scissors
 Tijeras finas para cirugía
 Forbici fine per chirurgia



WAGNER
 12,0 cm, 4 1/2"

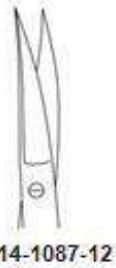
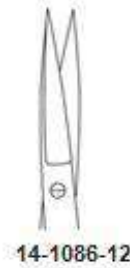
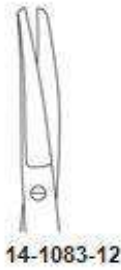
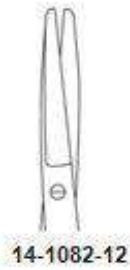

STRABISMUS
 11,5 cm, 4 1/2"



IRIS

9,0 cm, 4 1/2"	14-1088-09
10,5 cm, 4 1/2"	14-1088-10
11,5 cm, 4 1/2"	14-1088-11



IRIS

9,0 cm, 4 1/2"	14-1089-09
10,5 cm, 4 1/2"	14-1089-10
11,5 cm, 4 1/2"	14-1089-11





Feine chirurgische Scheren
Fine surgical scissors
Tijeras finas para cirugía
Forbici fine per chirurgia



IRIS

10,5 cm, 4 1/2"
11,5 cm, 4 1/2" 14-1090-10
14-1090-11



IRIS

10,5 cm, 4 1/2"
11,5 cm, 4 1/2" 14-1091-10
14-1091-11



11,5 cm, 4 1/2"
14-1092-11



11,5 cm, 4 1/2"
14-1093-11



Feine chirurgische Scheren
Fine surgical scissors
Tijeras finas para cirugía
Forbici fine per chirurgia



12,0 cm, 4 1/4"



14-1094-12



14-1095-12



MOD.BONN
8,0 cm, 3 1/4"
14-1096-08



MOD.BONN
8,0 cm, 3 1/4"
14-1097-08



MOD.BONN
8,0 cm, 3 1/4"
14-1098-08

Feine chirurgische Scheren
 Fine surgical scissors
 Tijeras finas para cirugía
 Forbici fine per chirurgia



BROPHY(SULLIVAN)
 14,0 cm, 5½"
 14-1099-14



BROPHY(SULLIVAN)
 14,0 cm, 5½"
 14-1100-14



10,5 cm, 4½"	14-1101-10	14-1102-10	14-1103-10	14-1104-10
11,5 cm, 4½"	14-1101-11	14-1102-11	14-1103-11	14-1104-11



14-1105-12 14-1106-12 14-1107-12



LANDOLT
 12,5 cm, 5"



STEVENS



Chirurgische Scheren
Surgical scissors
Tijeras para cirugía
Forbici per chirurgia



13,0 cm, 5"
14,5 cm, 5 3/4"

Inzisionsscheren
Incision scissors
Tijeras para incisión
Forbici vascolare e per fistole



14-1109-16
16,5 cm, 36 1/2"

Inzisionsscheren
Incision scissors
Tijeras para incisión
Forbici vascolare e per fistole



RICHTER
14,5 cm, 5 3/4"
14-1110-14



LAWSONTAIT
12,5 cm, 5"
14-1111-12



FERGUSSON
16,5 cm, 6 1/2"
18,0 cm, 7"



TOENNIS
18,0 cm, 7"
14-1112-18

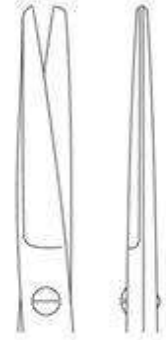

Chirurgische Scheren, Ligaturscheren
 Surgical scissors, Ligature Scissors
 Tijeras para cirugía, Tijeras para ligaduras
 Forbici per chirurgia, Forbici per legature



TOENNIS
 18,0 cm, 7"
 14-1114-18



HALLE
 19,0 cm, 7½"
 14-1115-19



FOMON
 15,0 cm, 6"
 14-1116-15



SPENCER
 9,0 cm, 4½"
 14-1117-09
 10,5 cm, 4½"
 14-1117-10
 13,0 cm, 5"
 14-1117-13



LITTAUER
 11,5 cm, 4½"
 14-1118-11
 14,0 cm, 5½"
 14-1118-14



BUCK



14,5 cm, 5½"
 14-1119-14

18,0 cm, 7"
 14-1120-18



Ligaturscheren, Neurochirurgische Scheren
 Ligature Scissors, Neurosurgical Scissors
 Tijeras para ligaduras, Tijeras para Neurocirugía
 Forbici per legature, Forbici per Neurochirurgia

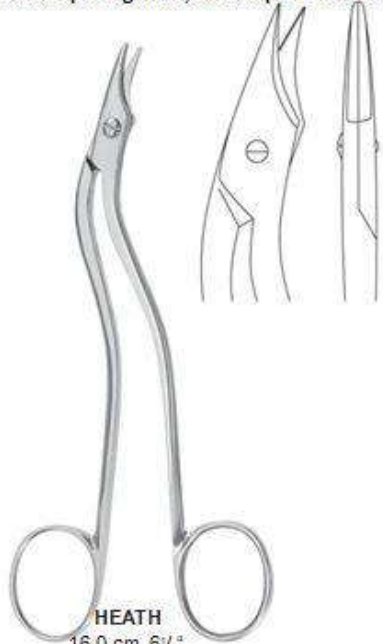

HEATH
 16,0 cm, 6 1/4"
 14-1121-16



NORTHBENT
 9,0 cm, 3 1/2"
 14-1122-09



NORTHBENT
 13,0 cm, 5"
 14-1123-13



EISELBERG
 12,0 cm, 4 3/4"
 14-1124-12



STRULLY
 22,0 cm, 8 1/2"
 14-1125-22

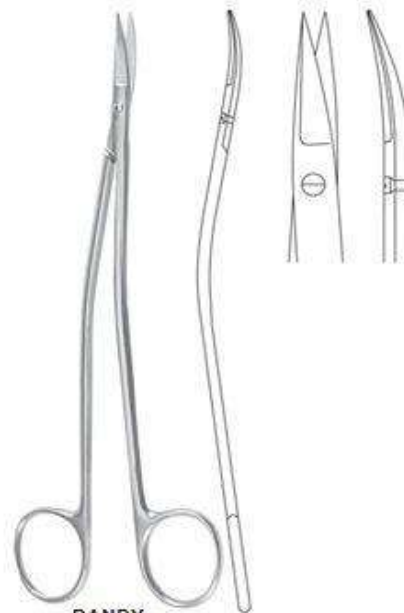

DANDY
 17,0 cm, 6 3/4"
 14-1126-17

Neurochirurgische Scheren, Tonsillenscheren, Nasenscheren
 Neurosurgical Scissors, Tonsil Scissors, Nasal Scissors
 Tijeras para Neurocirugía, Tijeras para amígdalas, Tijeras para el tabique nasal
 Forbici per Neurochirurgia, Forbici per tonsille, Forbici per il setto nasale



SCHMIEDEN-TAYLOR
 17,0 cm, 6 1/2"
 14-1127-17



LINCOLN
 17,0 cm, 6 1/2"



HEYMANN
 18,0 cm, 7"
 14-1130-18



COTTLE
 16,0 cm, 6 1/4"
 14-1131-16



KIRSTEN
 18,0 cm, 7"
 14-1132-18



CAPLAN
 22,0 cm, 8 1/2"
 14-1133-22



Tonsillenscheren, Nasenscheren, Gefäßscheren
 Tonsil Scissors, Nasal Scissors, Vascular Scissors
 Tijeras para amígdalas, Tijeras para el tabique nasal, Tijeras vasculares
 Forbici per tonsille, Forbici per il setto nasale, Forbici vascolari



BOETTCHER
 18,0 cm, 7"
 14-1134-18



PRINCE
 17,5 cm, 6 7/8"
 14-1135-17



GOOD
 19,0 cm, 7 1/2"
 14-1136-19



CARTILAGE
 20,0 cm, 8"
 14-1137-20



DEBAKEY

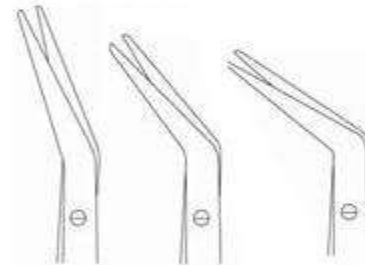

25° 45° 60°

17,5cm, 6 7/8"	14-1138-25	14-1143-45	14-1148-60
19,5cm, 7 7/8"	14-1139-25	14-1144-45	14-1149-60
21,0cm, 8 1/2"	14-1140-25	14-1145-45	14-1150-60
23,0cm, 9"	14-1141-25	14-1146-45	14-1151-60
28,0 cm, 11"	14-1142-25	14-1147-45	14-1152-60

Gefäßscheren
 Vascular Scissors
 Tijeras vasculares
 Forbici vascolari



POTTS-SMITH
 18,0 cm, 7°
 14-1143-18



POTTSDEMARTEL	
21,0 cm, 8 1/2°	14-1144-21
24,0 cm, 9 1/2°	14-1144-24

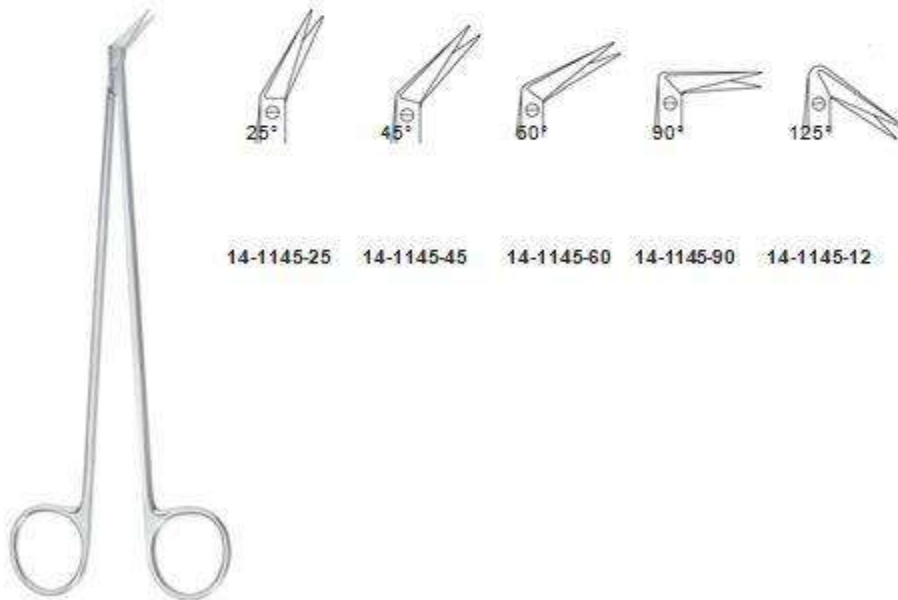

DIETRICH-HEGEMANN
 19,0 cm, 7 1/2°

14-1145-25 14-1145-45 14-1145-60 14-1145-90 14-1145-12

Gefäßscheren
Vascular Scissors
Tijeras vasculares
Forbici vascolari



DIETRICH
20,0 cm, 7 1/2"
14-1148-12

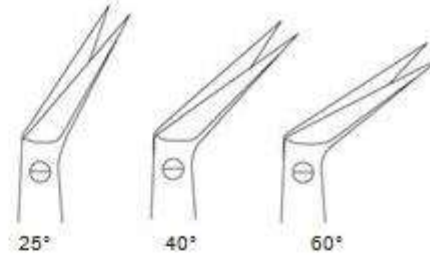

14-1147-25 14-1147-45 14-1147-60

POTTS-SMITH
19,0 cm, 7 1/2"



DEBAKEY
15,5 cm, 6"
14-1149-15



DEBAKEY
15,5 cm, 6"
14-1150-15



DEBAKEY
15,5 cm, 6"
14-1151-15

Gefäßscheren, Gynäkologische Scheren
 Vascular Scissors, Gynecology scissors
 Tijeras vasculares, Tijeras para ginecología
 Forbici vascolari, Forbici per ginecologia



MCINDOE
 19,0 cm, 7 1/2"
 14-1152-19



geköpftes Blatt
 probe-pointed blade
 punta bottonda
 lame bottonuta

11,5 cm, 4 1/2"
 14-1153-11



CRAFOORD
 30,0 cm, 12"
 14-1154-30



SATINSKY
 15,5 cm, 9 1/4"
 14-1155-24



KLINGENBERG-LOTH

23,0 cm, 9"
 14-1162-23



SIMS



20,0 cm, 8"	14-1156-20	14-1157-20	14-1158-20
23,0 cm, 9"	14-1159-23	14-1160-23	14-1161-23

Gynäkologische Scheren
Gynecology scissors
Tijeras para ginecología
Forbici per ginecologia



20,0 cm, 8"	14-1163-20	14-1164-20	14-1165-20
23,0 cm, 9"	14-1166-23	14-1167-23	14-1168-23



24,0 cm, 9 1/2"
14-1169-24



22,0 cm, 8 1/2"
14-1170-22



16,0 cm, 6 1/4"	14-1171-16	14-1172-16	14-1173-16
17,5 cm, 6 7/8"	14-1174-17	14-1175-17	14-1176-16



16,0 cm, 6 1/4"	14-1177-16
18,0 cm, 7"	14-1177-17

Fistelscheren
Fistula
scissors
Tijeras
para fistulas
Forbici
per fistole



Fistelschere/Fistula
scissors Tijeras
para fistulas Forbici
per fistole

KELLY	
16,0 cm, 6 1/4"	14-1179-16
18,0 cm, 7"	14-1179-18



WERTHEIM	
19,5 cm, 7 3/4"	14-1180-19
22,5 cm, 8 7/8"	14-1180-23

Gynäkologische Scheren, Darmschere
Gynecology scissors, Enterotomy Scissors
Tijeras para ginecología, Tijeras enterótomas
Forbici per ginecologia, Forbici per enterotomia



14-1178-18

DUBOIS
27,0 cm, 10 3/4"
14-1181-18



DARMSCHERE
21,0 cm, 8 1/4"
14-1182-21



DARMSCHERE
21,0 cm, 8 1/4"
14-1183-21



DARMSCHERE
GEKNOPFT
21,0 cm, 8 1/4"
14-1184-21



LLOYD-DAVIES
27,0 cm, 10 3/4"
14-1185-27





Lungenlappen- und Rektumscheren, Lungenscheren, Dammscheren Lobectomy and Rectal Scissors, Lobectomy Scissors, Episiotomy Scissors Tijeras para lobectomía y recto, Tijera para lobectomía, Tijeras para episiotomía, Forbici per lobo polmonare e per il retto, Forbici per lobo, Forbici perepisiotomia

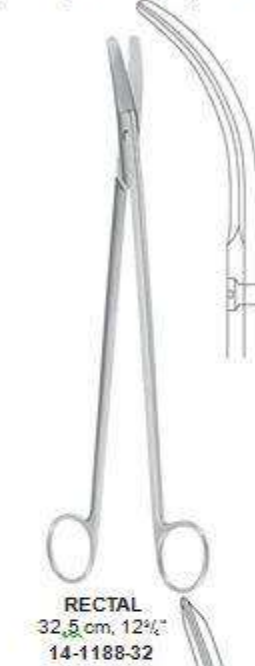

Lungenscheren, Dammscheren, Nabelschnurscheren
 Lobectomy Scissors, Episiotomy Scissors, Umbilical Cord Scissors
 Tijera para lobectomia, Tijeras para episiotomia, Tijeras umbilicales
 Forbici per lobo, Forbici perepisiotomia, Forbici ombelicali



WALDMANN
 18,0 cm, 7"
 14-1193-18



BRAUN-STADLER
 14,5 cm, 5 7/8" 14-1194-14
 20,0 cm, 8" 14-1194-20



EPISIOTOMIESCHERE
 20,0 cm, 8" 14-1195-20



MOD. USA
 10,5 cm, 4 1/8"
 14-1196-10



BUSCH
 13,5 cm, 5 1/8" 14-1197-13
 18,0 cm, 6 7/8" 14-1197-18



SCHUMACHER
 16,0 cm, 16 1/4"
 14-1198-16



Drahtscheren, Verband- und Kleiderstoffscheren
 Wire Scissors, Bandage and Cloth Scissors
 Cizallas corta-alambres, Tijeras para vendajes y tela
 Forbici taglia cavo, Forbici per bendaggi e vestiti



gezahnt
 serrated
 dentada
 dentata

UNIVERSAL
 12,0 cm, 4 1/2"
 14-1200-12



LISTER

9,0 cm, 3 1/2"	14-1199-09
11,0 cm, 4 1/4"	14-1199-11
14,0 cm, 5 1/2"	14-1199-14
18,0 cm, 7"	14-1199-18
20,0 cm, 8"	14-1199-20



LISTER

18,5 cm, 7 1/2"	14-1201-18
21,0 cm, 8 1/4"	14-1201-21



gezahnt
 serrated
 dentada
 dentata

LISTER-EXCENTRIC

16,0 cm, 6 1/4"	14-1202-16
19,0 cm, 7 1/2"	14-1202-19

BERGMANN

23,0 cm, 9"	14-1203-23
-------------	------------

Verband- und Kleiderstoffscheren, Gipsscheren
 Bandage and Cloth Scissors, Plaster-of-Paris Shears
 Tijeras para vendajes y tela, Cizallas para escayolas
 Forbici per bendaggi e vestiti, Cesioie per gessi



ESMARCH
 20,0 cm, 8" 14-1204-20
 22,0 cm, 8 7/8" 14-1204-22



KNOWLES
 14,0 cm, 5 1/2" 14-1205-14



gezahnt
 serrated
 dentada
 dentata

BRUNS
 24,0 cm, 9 1/2" 14-1206-24
 14-1207-24



LORENZ
 23,0 cm, 9" 14-1208-23



SMITH (MOD USA)

16,0 cm, 6 1/4" 14-1209-16
 18,0 cm, 7" 14-1209-18
 20,0 cm, 8" 14-1209-20
 23,0 cm, 9" 14-1209-23



gezahnt
 serrated
 dentada
 dentata

GIPSSCHERE
 20,0 cm, 8" 14-1210-20

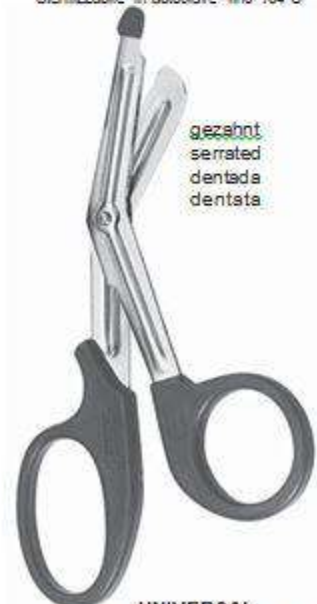

bis 134°C autoklavierbar
 autoclavable up to 134°C
 esterilizabile en autoclave hasta 134°C
 Sterilizzabile in autoclave fino 134°C

gezahnt
 serrated
 dentada
 dentata

UNIVERSAL
 14,0 cm, 5 1/2" 14-1211-14
 16,0 cm, 6 1/4" 14-1211-16
 18,0 cm, 7" 14-1211-18



[Back to Index](#)

[Use right click for next or previous page](#)

Chirurgische Scheren mit Hartmetallschneiden
 Surgical Scissors with tungsten carbide edges
 Tijeras para cirugía con filos de carburo tungsteno
 Forbici per chirurgia con lame in carburo di tungsteno



STANDARD
 14,5 cm, 5 7/8" 14-1212-14-TC
 16,5 cm, 6 1/2" 14-1212-16-TC
 18,5 cm, 7 1/2" 14-1212-18-TC



STANDARD
 14,5 cm, 5 7/8" 14-1213-14-TC
 16,5 cm, 6 1/2" 14-1213-16-TC
 18,5 cm, 7 1/2" 14-1213-18-TC



STANDARD
 14,5 cm, 5 7/8" 14-1214-14-TC
 16,5 cm, 6 1/2" 14-1214-16-TC
 18,5 cm, 7 1/2" 14-1214-18-TC



STANDARD
 14,5 cm, 5 7/8" 14-1215-14-TC
 16,5 cm, 6 1/2" 14-1215-16-TC
 18,5 cm, 7 1/2" 14-1215-18-TC



STANDARD
 14,5 cm, 5 7/8" 14-1216-14-TC
 16,5 cm, 6 1/2" 14-1216-16-TC
 18,5 cm, 7 1/2" 14-1216-18-TC



STANDARD
 14,5 cm, 5 7/8" 14-1217-14-TC
 16,5 cm, 6 1/2" 14-1217-16-TC
 18,5 cm, 7 1/2" 14-1217-18-TC

Chirurgische Scheren mit Hartmetallschneiden
 Surgical Scissors with tungsten carbide edges
 Tijeras para cirugía con filos de carburo tungsteno
 Forbici per chirurgia con lame in carburo di tungsteno



MAYO
 14,5 cm, 5 1/2" 14-1218-14-TC
 17,0 cm, 6 1/2" 14-1218-17-TC
 23,0 cm, 9" 14-1218-23-TC



MAYO
 14,5 cm, 5 1/2" 14-1219-14-TC
 17,0 cm, 6 1/2" 14-1219-17-TC
 23,0 cm, 9" 14-1219-23-TC



MAYO-STILLE
 15,0 cm, 6" 14-1220-15-TC
 17,0 cm, 6 1/2" 14-1220-17-TC



MAYO-STILLE
 15,0 cm, 6" 14-1221-15-TC
 17,0 cm, 6 1/2" 14-1221-17-TC



LEXER
 16,0 cm, 6 1/4" 14-1222-16-TC
 21,0 cm, 8 1/4" 14-1222-21-TC



LEXER
 16,0 cm, 6 1/4" 14-1223-16-TC
 21,0 cm, 8 1/4" 14-1223-21-TC

Präparierscheren mit Hartmetallschneiden
 Dissecting Scissors with tungsten carbide edges
 Tijeras para disección con filos de carburo tungsteno
 Forbici per dissezione con lame in carburo di tungsteno

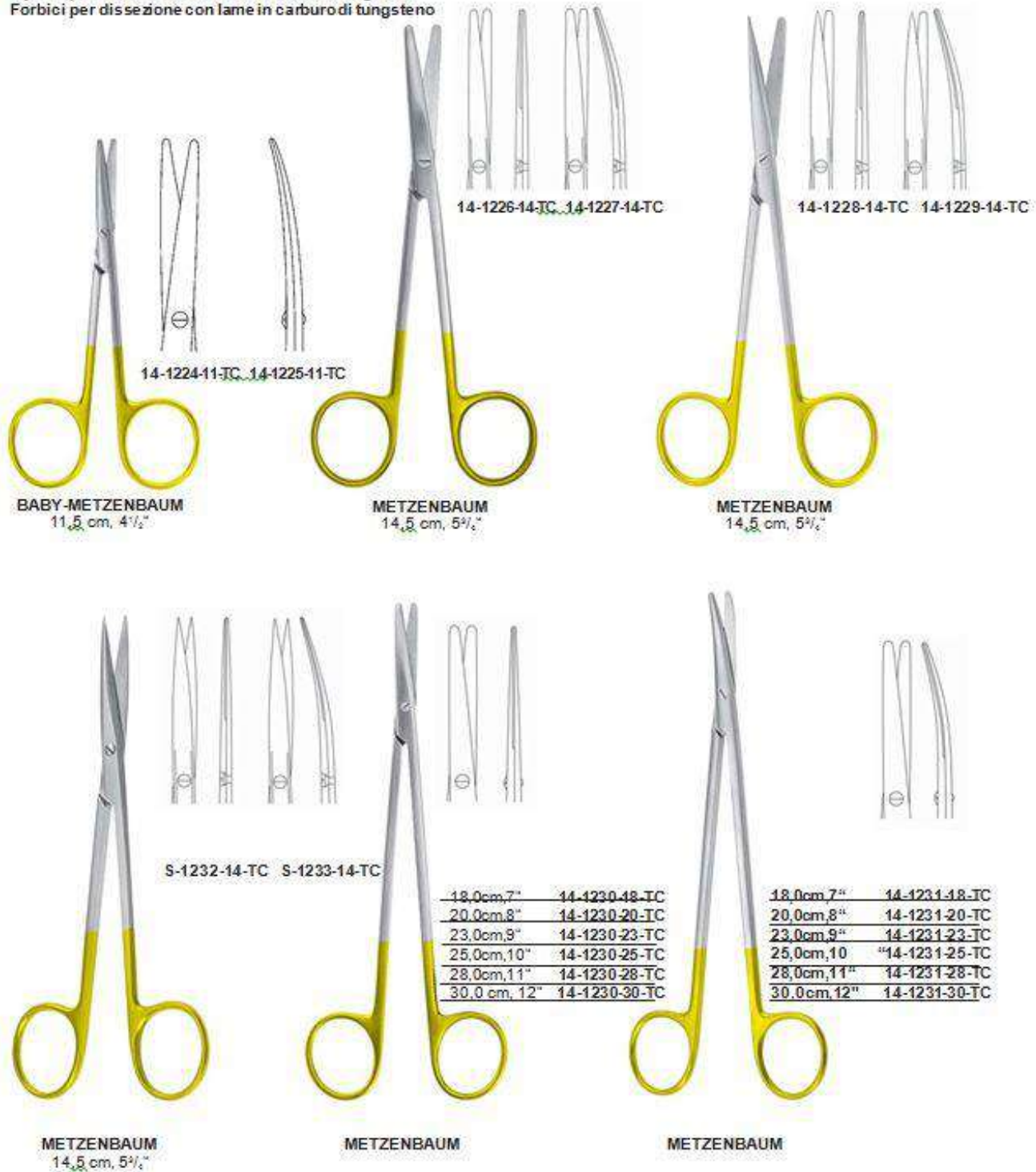

14-1224-11-TC, 14-1225-11-TC

14-1226-14-TC, 14-1227-14-TC

14-1228-14-TC, 14-1229-14-TC

BABY-METZENBAUM
11,5 cm, 4 1/2"

METZENBAUM
14,5 cm, 5 1/2"

METZENBAUM
14,5 cm, 5 1/2"

S-1232-14-TC, S-1233-14-TC

18,0cm, 7"	14-1230-18-TC	18,0cm, 7"	14-1231-18-TC
20,0cm, 8"	14-1230-20-TC	20,0cm, 8"	14-1231-20-TC
23,0cm, 9"	14-1230-23-TC	23,0cm, 9"	14-1231-23-TC
25,0cm, 10"	14-1230-25-TC	25,0cm, 10"	14-1231-25-TC
28,0cm, 11"	14-1230-28-TC	28,0cm, 11"	14-1231-28-TC
30,0 cm, 12"	14-1230-30-TC	30,0cm, 12"	14-1231-30-TC

METZENBAUM
14,5 cm, 5 1/2"

METZENBAUM

METZENBAUM



18,0cm,7"	14-1234-18-TC
20,0cm,8"	14-1234-20-TC
23,0cm,9"	14-1234-23-TC
25,0cm,10"	14-1234-25-TC
28,0cm,11"	14-1234-28-TC
30,0 cm, 12"	14-1234-30-TC

18,0cm,7"	14-1235-18-TC
20,0cm,8"	14-1235-20-TC
23,0cm,9"	14-1235-23-TC
25,0cm,10"	14-1235-25-TC
28,0cm,11"	14-1235-28-TC
30,0 cm, 12"	14-1235-30-TC

18,0cm,7"	14-1236-18-TC
20,0cm,8"	14-1236-20-TC
23,0cm,9"	14-1236-23-TC
25,0cm,10"	14-1236-25-TC
28,0cm,11"	14-1236-28-TC
30,0 cm, 12"	14-1236-30-TC

METZENBAUM METZENBAUM METZENBAUM

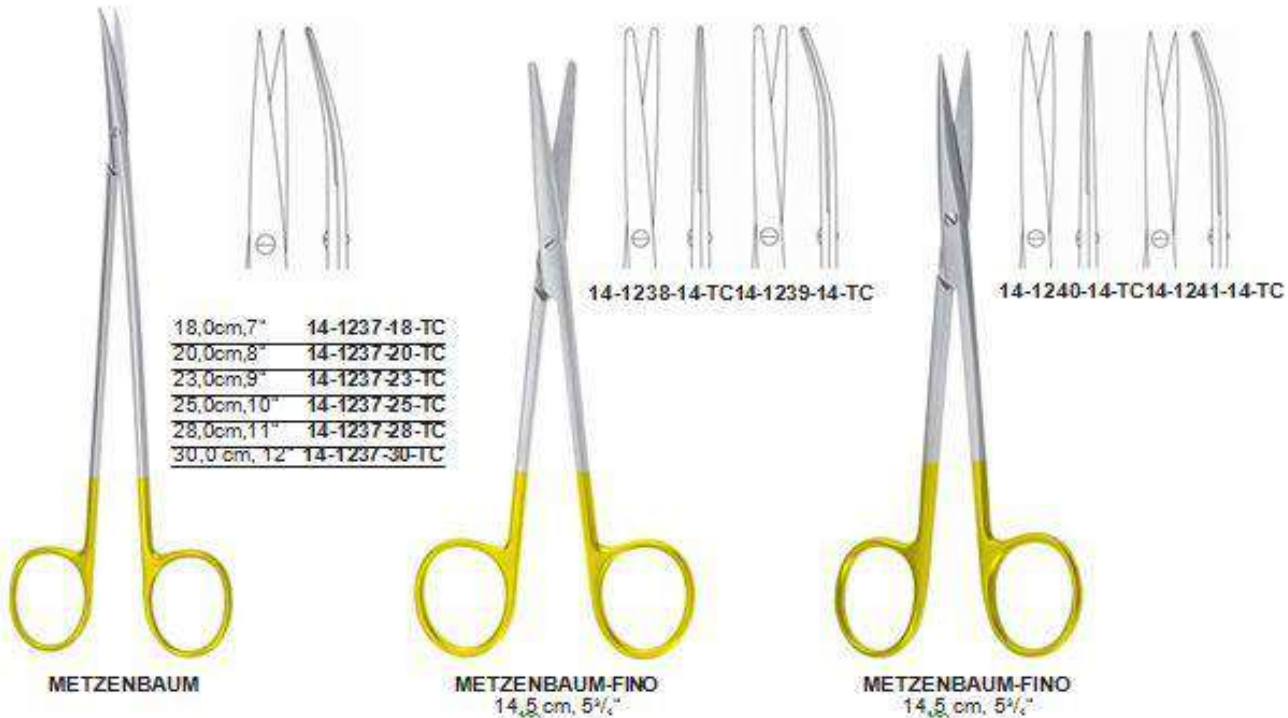

18,0cm,7"	14-1237-18-TC
20,0cm,8"	14-1237-20-TC
23,0cm,9"	14-1237-23-TC
25,0cm,10"	14-1237-25-TC
28,0cm,11"	14-1237-28-TC
30,0 cm, 12"	14-1237-30-TC

14-1238-14-TC 14-1239-14-TC

14-1240-14-TC 14-1241-14-TC

METZENBAUM METZENBAUM-FINO METZENBAUM-FINO

14,5 cm, 5 1/2"

Präparierscheren mit Hartmetallschneiden
 Dissecting Scissors with tungsten carbide edges
 Tijeras para disección con filos de carburo tungsteno
 Forbici per dissezione con lame in carburo di tungsteno



18,0cm,7"	14-1242-18-TC
20,0cm,8"	14-1242-20-TC
23,0cm,9"	14-1242-23-TC
25,0cm,10"	14-1242-25-TC
28,0cm,11"	14-1242-28-TC
30,0 cm, 12"	14-1242-30-TC

METZENBAUM-FINO

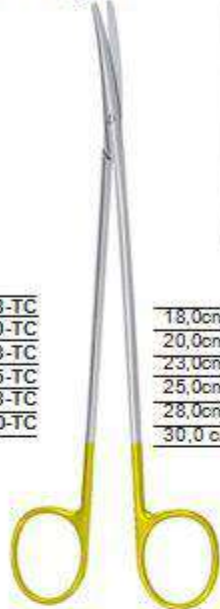

18,0cm,7"	14-1243-18-TC
20,0cm,8"	14-1243-20-TC
23,0cm,9"	14-1243-23-TC
25,0cm,10"	14-1243-25-TC
28,0cm,11"	14-1243-28-TC
30,0 cm, 12"	14-1243-30-TC

METZENBAUM-FINO



18,0cm,7"	14-1244-18-TC
20,0cm,8"	14-1244-20-TC
23,0cm,9"	14-1244-23-TC
25,0cm,10"	14-1244-25-TC
28,0cm,11"	14-1244-28-TC
30,0 cm, 12"	14-1244-30-TC

METZENBAUM-FINO



18,0cm,7"	14-1245-18-TC
20,0cm,8"	14-1245-20-TC
23,0cm,9"	14-1245-23-TC
25,0cm,10"	14-1245-25-TC
28,0cm,11"	14-1245-28-TC
30,0 cm, 12"	14-1245-30-TC

METZENBAUM-FINO



METZENBAUM-LAHEY
 14,0 cm, 5 1/2"
 14-1246-14-TC



TOENNIS-ADSON
 17,0 cm, 6 1/2"
 14-1247-17-TC

Präparierscheren mit Hartmetallschneiden
 Dissecting Scissors with tungsten carbide edges
 Tijeras para disección con filos de carburotungsteno
 Forbici per dissezione con lame in carburo di tungsteno



18,0cm, 7"	14-1248-18-TC
20,0cm, 8"	14-1248-20-TC
23,0 cm, 9"	14-1248-23-TC

METZENBAUM-FINOS

18,0cm, 7"	14-1249-18-TC
20,0cm, 8"	14-1249-20-TC
23,0 cm, 9"	14-1249-23-TC

METZENBAUM-FINOS

REYNOLDS
 15,0 cm, 6"
 14-1250-15-TC



REYNOLDS
 15,0 cm, 6"
 14-1251-15-TC



HYSTEREKTOMY
 25,5 cm, 10"
 14-1252-25-TC



HYSTEREKTOMY
 Y 25,0 cm, 9 1/2"
 14-1253-25-TC

Gynäkologische Scheren mit Hartmetallschneiden
 Gynecology Scissors with tungsten carbide edges
 Tijeras para ginecología con filos de carburotungsteno
 Forbici per ginecologia con lame in carburo di tungsteno



20,0 cm, 8"	14-1254-20-TC	14-1255-20-TC	14-1256-20-TC
23,0 cm, 9"	14-1254-23-TC	14-1255-23-TC	14-1256-23-TC



20,0 cm, 8"	14-1257-20-TC	14-1258-20-TC	14-1259-20-TC
23,0 cm, 9"	14-1257-23-TC	14-1258-23-TC	14-1259-23-TC

Gefäßscheren mit Hartmetallschneiden
 Vascular Scissors with tungsten carbide edges
 Tijeras vasculares con filos de carburo tungsteno
 Forbici vascolari con lame in carburo di tungsteno



DIETRICH
 17,5 cm, 6⁷/₁₆"
 14-1260-17-TC



POTTSDEMARTEL
 24,0 cm, 9¹/₂"
 14-1261-24-TC



DEBAKEY

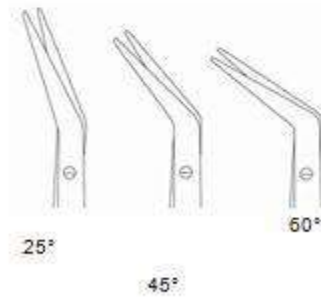

20,0 cm, 8" 14-1262-25-TC 14-1264-45-TC 14-1266-60-TC
 23,0 cm, 9" 14-1263-25-TC 14-1265-45-TC 14-1267-60-TC

Gefäßscheren mit Hartmetallschneiden
 Vascular Scissors with tungsten carbide edges
 Tijeras vasculares con filos de carburo tungsteno
 Forbici vascolari con lame in carburo di tungsteno



DIETRICH-HEGEMANN
 18,0 cm, 7"

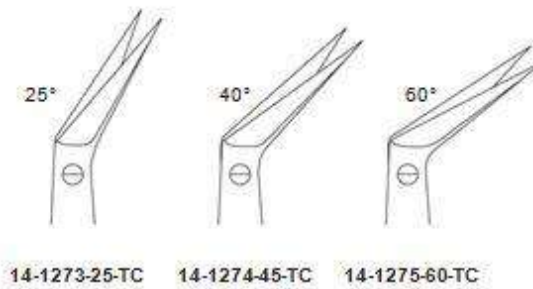

POTTS-SMITH
 18,0 cm, 7 1/2"



Scheren mit Hartmetallschneiden
 Scissors with tungsten carbide edges
 Tijeras con filos de carburo tungsten
 Forbici con lame in carburo di tungsteno



14-1277-11-TC 14-1278-11-TC

IRIS
 11,5 cm, 4 1/2"



gezahnt
 serrated
 dentada
 dentata

UNIVERSAL
 12,0 cm, 4 1/2"
 14-1279-12-TC



LISTER
 18,0 cm, 7"
 14-1280-18-TC

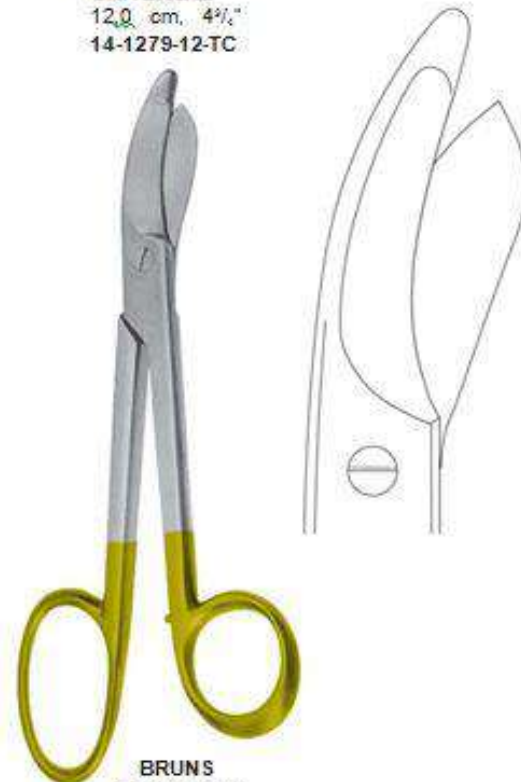

BRUNS
 24,0 cm, 9 1/2"
 14-1281-24-TC



Super-Cut Scheren Super-Cut
Scissors Tijeras Super-Cut Forbici
Super-Cut



MAYO FINO
17,0 cm, 6 1/2"

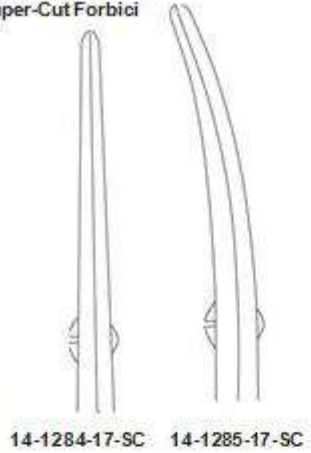

14-1284-17-SC 14-1285-17-SC



METZENBAUM

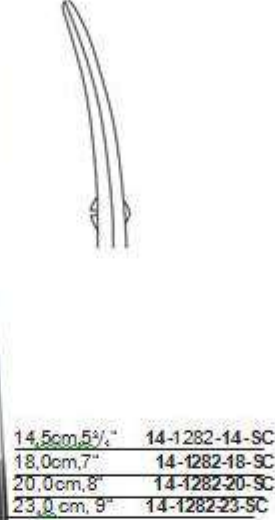

14,5cm, 5 3/4"	14-1282-14-SC
18,0cm, 7"	14-1282-18-SC
20,0cm, 8"	14-1282-20-SC
23,0 cm, 9"	14-1282-23-SC



METZENBAUM

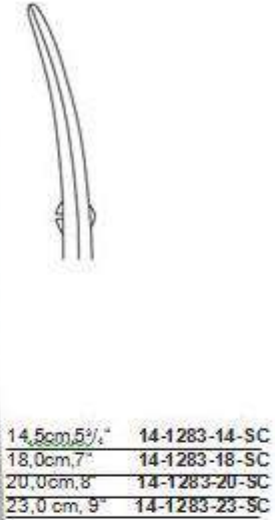

14,5cm, 5 3/4"	14-1283-14-SC
18,0cm, 7"	14-1283-18-SC
20,0cm, 8"	14-1283-20-SC
23,0 cm, 9"	14-1283-23-SC



15,0 cm, 6" 14-1286-15-SC
19,0 cm, 7 1/2" 14-1287-19-SC



KAYEFACELIFTJABAL
13,0 cm, 5"
14-1288-13-SC



ENDARTERECTOMY
18,0 cm, 7"
14-1289-18-SC



TOENNIS-ADSON
17,0 cm, 6 1/2"
14-1290-17-SC



Super-Cut Scheren
Super-Cut Scissors
Tijeras Super-Cut
Forbici Super-Cut



STRABISMUS
11,5 cm, 4 1/2"

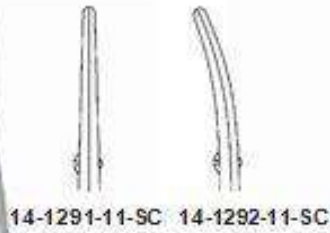

14-1291-11-SC 14-1292-11-SC



JAMISON
15,0 cm, 6" 14-1293-15-SC
18,0 cm, 7" 14-1293-18-SC



REYNOLDS
12,5 cm, 5" 14-1294-12-SC



BABY-METZENBAUM
11,0 cm, 4 1/2" 14-1295-11-SC
14,5 cm, 5 1/2" 14-1295-14-SC



IRIS
11,0 cm, 4 1/2" 14-1296-11-SC



IRIS
11,0 cm, 4 1/2" 14-1297-11-SC



STEVENSTENTOMY
11,0 cm, 4 1/2" 14-1298-11-SC



STEVENSTENTOMY
11,0 cm, 4 1/2" 14-1299-11-SC



Super-Cut Scheren
Super-Cut Scissors
Tijeras Super-Cut
Forbici Super-Cut



PARTYPE
12,0 cm, 4 1/2"
14-1303-12-SC



PARTYPE
12,0 cm, 4 1/2"
14-1304-12-SC



POTTS
19,0 cm, 7 1/2"



14-1300-25-SC



14-1301-45-SC



14-1302-60-SC



FOMON
14,5 cm, 5 1/2"
14-1305-15-SC



COTTLE
16,5 cm, 6 1/2"
14-1306-16-SC

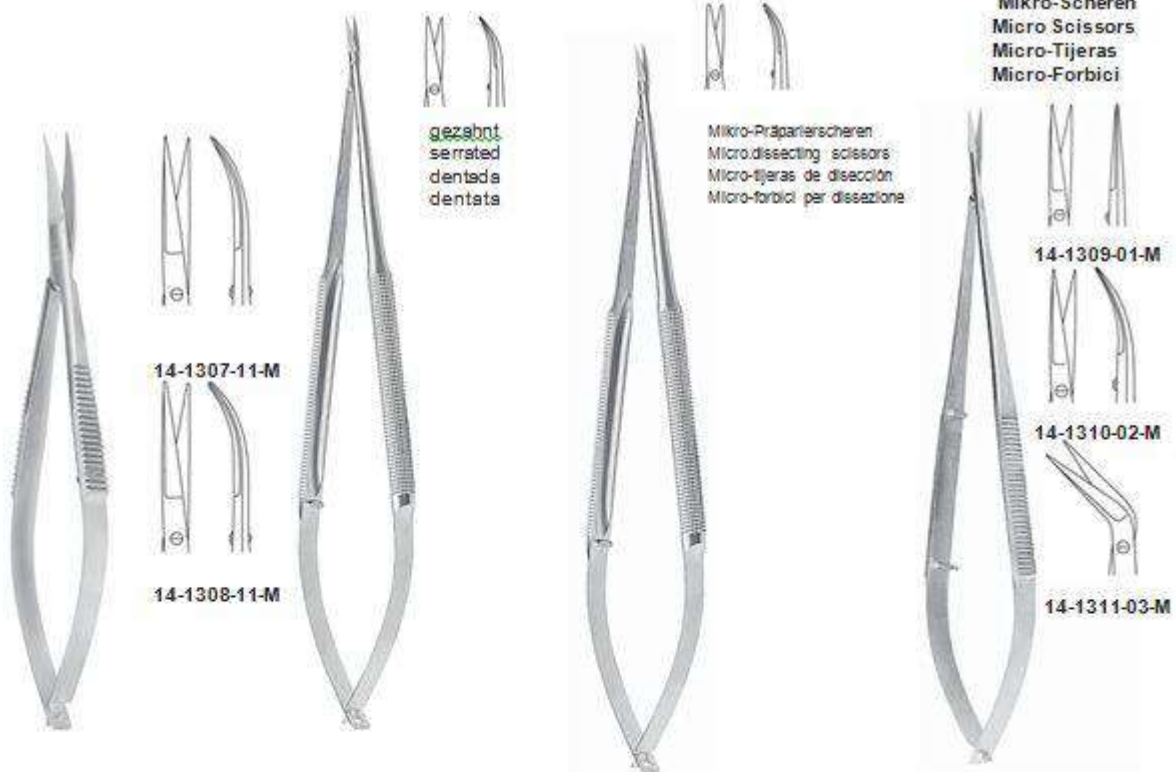

GOMEL		HEPP SCHEIDEL	
14,0 cm, 5 1/2"	14-1312-14-M	14,0 cm, 5 1/2"	14-1313-14-M
16,0 cm, 6 1/4"	14-1312-16-M	16,0 cm, 6 1/4"	14-1313-16-M



18,5 cm, 7 1/4"	14-1314-01	14-1315-02	14-1316-03	14-1318-04
22,5 cm, 8 3/4"	14-1319-01	14-1320-02	14-1321-03	14-1322-04



18,5 cm, 7 1/4"	14-1323-01-M	14-1325-02-M
22,5 cm, 8 3/4"	14-1324-01-M	14-1326-02-M

SIMS

Mikro-Scheren, Mikro-Dissektions-scheren
 Micro Scissors, Micro Dissecting Scissors
 Micro-Tijeras, Micro-Tijeras de disección
 Micro-Forbici, Micro-Forbici per dissezione



18,0 cm, 7°



14-1327-25-M



14-1328-45-M



14-1329-60-M



14-1330-90-M



14-1331-12-M



14-1332-25-M



14-1333-45-M



14-1334-60-M

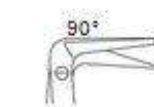

14-1335-90-M



14-1336-12-M



15,0 cm, 6°
14-1337-15-M



15,0 cm, 6°
14-1338-15-M



gezahnt
serrated
dentada
dentata



15,0 cm, 6°
14-1339-15-M

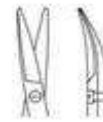

18,0 cm, 7°
14-1340-18-M





Mikro-Adventitiascheren
Micro Adventitia Scissors
Micro-Tijeras Adventitia
Micro-Forbici Adventitia



15,0 cm, 6"
14-1341-15-M



15,0 cm, 6"
14-1342-15-M



gezahnt
serrated
dentada
dentata



15,0 cm, 6"
14-1343-15-M

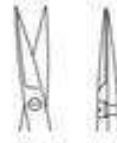

18,0 cm, 7"
14-1344-18-M



Anatomische Pinzetten
Dissecting Forceps
Pinzas de disección
Pinze anatomiche per dissezione



schmal
narrow
estrechos
stretti



schmal
narrow
estrechos
stretti



fein
fine
finas
fini

STANDARD	
10,5cm, 4 1/2"	14-1345-10
11,5cm, 4 1/2"	14-1345-11
13,0cm, 5"	14-1345-13
14,5cm, 5 1/2"	14-1345-14
15,0cm, 6"	14-1345-15
16,0cm, 6 1/2"	14-1345-16
18,0cm, 7"	14-1345-18
20,0cm, 8"	14-1345-20
25,0cm, 10"	14-1345-25
30,0cm, 12"	14-1345-30

STANDARD	
10,5cm, 4 1/2"	14-1346-10
11,5cm, 4 1/2"	14-1346-11
13,0cm, 5"	14-1346-13
14,5cm, 5 1/2"	14-1346-14
15,0cm, 6"	14-1346-15
16,0cm, 6 1/2"	14-1346-16
18,0cm, 7"	14-1346-18
20,0cm, 8"	14-1346-20
25,0cm, 10"	14-1346-25
30,0cm, 12"	14-1346-30

STANDARD	
10,5cm, 4 1/2"	14-1347-10
11,5cm, 4 1/2"	14-1347-11
13,0cm, 5"	14-1347-13
14,5cm, 5 1/2"	14-1347-14
15,0cm, 6"	14-1347-15
16,0cm, 6 1/2"	14-1347-16
18,0cm, 7"	14-1347-18
20,0cm, 8"	14-1347-20
25,0cm, 10"	14-1347-25
30,0cm, 12"	14-1347-30

STANDARD	
10,5cm, 4 1/2"	14-1348-10
11,5cm, 4 1/2"	14-1348-11
13,0cm, 5"	14-1348-13
14,5cm, 5 1/2"	14-1348-14
15,0cm, 6"	14-1348-15
16,0cm, 6 1/2"	14-1348-16
18,0cm, 7"	14-1348-18
20,0cm, 8"	14-1348-20
25,0cm, 10"	14-1348-25
30,0cm, 12"	14-1348-30



Anatomische Pinzetten
Dissecting Forceps
Pinzas de disección
Pinze anatomiche per dissezione



fein
ne
finas
fini



feinfi
fine
finas
fini

mit Stiftwäh
pincon
perno con
espiga



schmal
narrow
estrechos
stretti

10,5cm,4 1/2"	14-1349-10
11,5cm,4 1/2"	14-1349-11
13,0cm,5"	14-1349-13
14,5cm,5 1/2"	14-1349-14
16,0cm,6 1/2"	14-1349-16
18,0cm,7"	14-1349-18
20,0cm,8"	14-1349-20
25,0cm,10"	14-1349-25
30,0cm,12"	14-1349-30

10,5cm,4 1/2"	14-1350-10
11,5cm,4 1/2"	14-1350-11
13,0cm,5"	14-1350-13
14,5cm,5 1/2"	14-1350-14
16,0cm,6 1/2"	14-1350-16
18,0cm,7"	14-1350-18
20,0cm,8"	14-1350-20
25,0cm,10"	14-1350-25
30,0cm,12"	14-1350-30

MOD.USA	
12,0 cm, 4 1/2"	14-1351-10
13,0 cm, 5"	14-1351-13
14,5 cm, 5 1/2"	14-1351-14
15,0 cm, 6"	14-1351-15
18,0 cm, 7"	14-1351-18
20,0 cm, 8"	14-1351-20
25,5 cm, 10"	14-1351-25
30,0 cm, 12"	14-1351-30

MOD.USA	
12,0 cm, 4 1/2"	14-1352-11
13,0 cm, 5"	14-1352-13
14,5 cm, 5 1/2"	14-1352-14
15,0 cm, 6"	14-1352-15
18,0 cm, 7"	14-1352-18
20,0 cm, 8"	14-1352-20
25,5 cm, 10"	14-1352-25



Anatomische Pinzetten
Dissecting Forceps
Pinzas de disección
pinze anatomiche per dissezione



ADSON
12,0 cm, 4 1/2" 14-1353-12
15,0 cm, 6" 14-1353-15



MICRO-ADSON
12,0 cm, 4 1/2" 14-1354-12
15,0 cm, 6" 14-1354-15



STILLE
15,0 cm, 6" 14-1355-15



MCINDOE
15,0 cm, 6" 14-1356-15



TAYLOR
17,5 cm, 6 3/4" 14-1357-17



TAYLOR
17,5 cm, 6 3/4" 14-1358-17



TAYLOR
18,5 cm, 7 1/4" 14-1359-18



GERALD
18,0 cm, 7" 14-1360-18



GERALD
 18,0 cm, 7"
 14-1361-18



POTTS-SMITH
 18,0 cm, 7" 14-1362-18
 21,0 cm, 8 1/4" 14-1362-21
 25,0 cm, 10" 14-1362-25



POTTS-SMITH
 18,0 cm, 7" 14-1363-18
 21,0 cm, 8 1/4" 14-1363-21
 25,0 cm, 10" 14-1363-25

Anatomische Pinzetten
 Dissecting Forceps
 Pinzas de disección
 Pinze anatomiche per dissezione



englische Modelle
 english patterns
 modelos ingleses
 modelli inglese

13,0 cm, 5" 14-1364-13
 14,5 cm, 5 1/2" 14-1364-14
 15,0 cm, 6" 14-1364-15



SEMKEN
 12,5 cm, 5" 14-1365-12
 15,0 cm, 6" 14-1365-15



CUSHING
 17,5 cm, 6 3/4"
 14-1366-17



CUSHING
 17,5 cm, 6 3/4"
 14-1367-17



BROPHY
 20,0 cm, 8"
 14-1368-20



Anatomische Pinzetten
Dissecting Forceps
Pinzas de disección
Pinze anatomiche per dissezione



BROPHY
20,0 cm, 8"
14-1369-20



BONNEY
18,0 cm, 7"
14-1370-18



SINGLE-TUTTLE
23,0 cm, 9"
14-1371-23



DENNISBROWN
20,0 cm, 8"
14-1372-20



DUEHRSEN
20,0 cm, 8"
14-1373-20



WAUGH
15,0 cm, 6" 14-1374-15
20,0 cm, 8" 14-1374-20



RAMSEY
18,0 cm, 7"
14-1375-18



Chirurgische Pinzetten
Tissue Forceps
Pinzas quirúrgicas
Pinze per chirurgia

 1x2

 2x3

 3x4

 4x5
**STANDARD**

10,5cm,4 ¹ / ₂ "	14-1376-10
11,5cm,4 ¹ / ₂ "	14-1376-11
13,0cm,5"	14-1376-13
14,5cm,5 ¹ / ₂ "	14-1376-14
15,0cm,5"	14-1376-15
16,0cm,6 ¹ / ₂ "	14-1376-16
18,0cm,7"	14-1376-18
20,0cm,8"	14-1376-20
25,0cm,10"	14-1376-25
30,0cm,12"	14-1376-30

11,5cm,4 ¹ / ₂ "	14-1377-11
13,0cm,5"	14-1377-13
14,5cm,5 ¹ / ₂ "	14-1377-14
16,0cm,6 ¹ / ₂ "	14-1377-16
18,0cm,7"	14-1377-18
20,0cm,8"	14-1377-20
25,0cm,10"	14-1377-25
30,0cm,12"	14-1377-30

13,0cm,5"	14-1378-13
14,5cm,5 ¹ / ₂ "	14-1378-14
16,0cm,6 ¹ / ₂ "	14-1378-16
18,0cm,7"	14-1378-18
20,0cm,8"	14-1378-20

13,0cm,5"	14-1379-13
14,5cm,5 ¹ / ₂ "	14-1379-14
16,0cm,6 ¹ / ₂ "	14-1379-16
18,0cm,7"	14-1379-18
20,0cm,8"	14-1379-20

Chirurgische Pinzetten
Tissue Forceps
Pinzas quirúrgicas
Pinze per chirurgia

1x2



fein
DE
finas
fini

13,0 cm, 5"	14-1380-13
14,5 cm, 5 1/2"	14-1380-14
15,5 cm, 6"	14-1380-15
16,0 cm, 6 1/2"	14-1380-16
18,0 cm, 7"	14-1380-18
20,0 cm, 8"	14-1380-20
25,0 cm, 10"	14-1380-25
30,0 cm, 12"	14-1380-30

1x2



mit
Stiftwith
pincon
pemo con
espiga

13,0 cm, 5"	14-1381-13
14,5 cm, 5 1/2"	14-1381-14
15,5 cm, 6"	14-1381-15
16,0 cm, 6 1/2"	14-1381-16
18,0 cm, 7"	14-1381-18
20,0 cm, 8"	14-1381-20
25,0 cm, 10"	14-1381-25
30,0 cm, 12"	14-1381-30

1x2



mit
Stiftwith
pincon
pemo con
espiga

13,0 cm, 5"	14-1382-13
14,5 cm, 5 1/2"	14-1382-14
16,0 cm, 6 1/2"	14-1382-16
18,0 cm, 7"	14-1382-18
20,0 cm, 8"	14-1382-20

1x2



englische Modelle
english patterns
modelos ingleses
modelli inglese

13,0 cm, 5"	14-1383-13
14,5 cm, 5 1/2"	14-1383-14
15,0 cm, 6"	14-1383-15



Chirurgische Pinzetten
Tissue Forceps
Pinzas quirúrgicas
Pinze per chirurgia

↔ 1x2



MOD.USA	
12,0 cm, 4 1/2"	14-1384-12
13,0 cm, 5"	14-1384-13
14,5 cm, 5 1/2"	14-1384-14
15,5 cm, 6"	14-1384-15
18,0 cm, 7"	14-1384-18
20,0 cm, 8"	14-1384-20
25,0 cm, 10"	14-1384-25
30,0 cm, 12"	14-1384-30

↔ 2x3



MOD.USA	
12,0 cm, 4 1/2"	14-1385-12
13,0 cm, 5"	14-1385-13
14,5 cm, 5 1/2"	14-1385-14
15,5 cm, 6"	14-1385-15
18,0 cm, 7"	14-1385-18
20,0 cm, 8"	14-1385-20
25,0 cm, 10"	14-1385-25
30,0 cm, 12"	14-1385-30

↔ 1x2



ADSON	
12,0 cm, 4 1/2"	14-1386-12
15,0 cm, 6"	14-1386-15

↔ 1x2



MICRO-ADSON	
12,0 cm, 4 1/2"	14-1387-12
15,0 cm, 6"	14-1387-15



Chirurgische pinzetten
Tissue Forceps
Pinzas quirúrgicas
Pinze per chirurgia

↔ 2x3



ADSON

12,0 cm, 4 1/2" 14-1388-12
15,0 cm, 6" 14-1388-15



ADSON-BROWN

12,0 cm, 4 1/2" 14-1389-12
15,0 cm, 6" 14-1389-15

↔ 1x2



ADSON

12,0 cm, 4 1/2" 14-1390-12

↔ 1x2



STILLE

15,0 cm, 6" 14-1391-15

↔ x3



STILLE

15,0 cm, 6" 14-1392-15

↔ 1x2



GILLIES

15,0 cm, 6" 14-1393-15

↔ 2x3



ADLERKREUTZ

15,0 cm, 6" 14-1394-15
20,0 cm, 8" 14-1394-20

↔ 4x5



ADLERKREUTZ

15,0 cm, 6" 14-1395-15
20,0 cm, 8" 14-1395-20



SEMKEN

12,5 cm, 5" 14-1396-12
15,5 cm, 6" 14-1396-15



SEMKEN

12,5 cm, 5" 14-1397-12



MCINDOE

15,0 cm, 6" 14-1398-15

Chirurgische Pinzetten
Tissue Forceps
Pinzas quirúrgicas
Pinze per chirurgia
1x2



TAYLOR

17,5 cm, 6 1/2" 14-1399-17



TAYLOR

17,5 cm, 6 1/2" 14-1400-17



TAYLOR

17,5 cm, 6 1/2" 14-1401-17



GERALD

18,0 cm, 7" 14-1402-18



GERALD

18,0 cm, 7" 14-1403-18

Chirurgische Pinzetten
Tissue Forceps
Pinzas quirúrgicas
Pinze per chirurgia

1x2



CUSHING
17,5 cm, 6 7/8"
14-1404-17

1x2



CUSHING
17,5 cm, 6 7/8"
14-1405-17

1x2



POTTS-SMITH
18,0 cm, 7" 14-1406-18
21,0 cm, 8 1/4" 14-1406-21
25,0 cm, 10" 14-1406-25

1x2



POTTS-SMITH
18,0 cm, 7" 14-1407-18
21,0 cm, 8 1/4" 14-1407-21
25,0 cm, 10" 14-1407-25



WAUGH
15,0 cm, 6" 14-1408-15
20,0 cm, 8" 14-1408-20



BROPHY
20,0 cm, 8" 14-1409-20



BROPHY
20,0 cm, 8" 14-1410-20



RUSS.MODELL
15,0 cm, 6" 14-1411-15
20,0 cm, 8" 14-1411-20
25,0 cm, 10" 14-1411-25



DURANTE
 14,5 cm, 5 7/8" 14-1413-14
 16,0 cm, 6 1/4" 14-1413-16
 20,0 cm, 8" 14-1413-20



DUEHRSEN
 20,0 cm, 8"

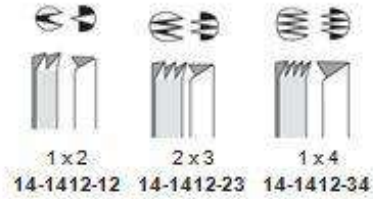

Chirurgische Pinzetten
 Tissue Forceps
 Pinzas quirúrgicas
 Pinze per chirurgia



NELSON
 15,0 cm, 6" 14-1414-15
 20,0 cm, 8" 14-1414-20
 23,0 cm, 9" 14-1414-23



DUVAL
 14,0 cm, 5 1/2"



COLLIN-DUVAL
 20,0 cm, 8"

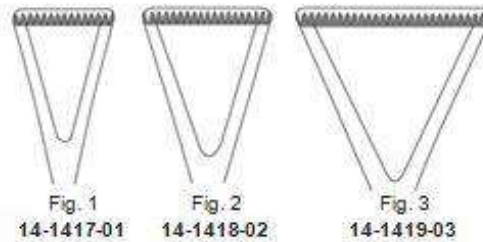



Chirurgische Pinzetten
Tissue Forceps
Pinzas quirúrgicas
Pinze per chirurgia



LANE
14,5 cm, 5 7/8" 14-1420-14
20,0 cm, 8" 14-1420-20



LANE
14,5 cm, 5 7/8" 14-1421-14
20,0 cm, 8" 14-1421-20



BROWN
15,0 cm, 6" 14-1422-15
20,0 cm, 8" 14-1422-20
25,0 cm, 10" 14-1422-25



TREVES
13,0 cm, 5" 14-1423-13
15,0 cm, 6" 14-1423-15



RAMSEY
18,0 cm, 7" 14-1424-18



RAMSEY
18,0 cm, 7" 14-1425-18



RAMSEY
18,0 cm, 7" 14-1426-18



RAMSEY
18,0 cm, 7" 14-1427-18



Splitterpinzetten
Splinter Forceps
Pinzas para espinas
Pinze per schegge

1 x 2

gerieft



gebogen
gerieft



mitStift



mitStift
abgeng
erieft



8,0cm,3 1/2"	14-1428-08
9,0cm,3 1/2"	14-1428-09
10,5cm,4 1/2"	14-1428-10
11,5 cm, 4 1/2"	14-1428-11
13,0cm,5"	14-1428-13
14,5 cm, 5 1/2"	14-1428-14

8,0cm,3 1/2"	14-1429-08
9,0cm,3 1/2"	14-1429-09
10,5cm,4 1/2"	14-1429-10
11,5 cm, 4 1/2"	14-1429-11
13,0cm,5"	14-1429-13
14,5 cm, 5 1/2"	14-1429-14

8,0cm,3 1/2"	14-1430-08
9,0cm,3 1/2"	14-1430-09
10,5cm,4 1/2"	14-1430-10
11,5 cm, 4 1/2"	14-1430-11
13,0cm,5"	14-1430-13
14,5 cm, 5 1/2"	14-1430-14

8,0cm,3 1/2"	14-1431-08
9,0cm,3 1/2"	14-1431-09
10,5cm,4 1/2"	14-1431-10
11,5cm,4 1/2"	14-1431-11
13,0cm,5"	14-1431-13
14,5 cm, 5 1/2"	14-1431-14



Splitterpinzetten, Mikro-Pinzetten
 Splinter Forceps, Micro Forceps
 Pinzas para espinas, Pinzas para microscopia
 Pinze per schegge, Pinze per microscopia



HUNTER
 10,5 cm, 4 1/2"
 14-1432-10



HUNTER
 10,5 cm, 4 1/2"
 14-1433-10



WALTER-CARMALT
 10,5 cm, 4 1/2"
 14-1434-10



WALTER-CARMALT
 10,5 cm, 4 1/2"
 14-1435-10



FEILCHENFELD
 7,5 cm, 3 1/2" 14-1436-07
 9,0 cm, 3 1/2" 14-1436-09
 11,5 cm, 4 1/2" 14-1436-11



10,0 cm, 4"
 14-1437-10



10,0 cm, 4"
 14-1438-10



10,0 cm, 4"
 14-1439-10
 selbsthaltend
 glatt

Mikro-Pinzetten
MicroForceps
Pinzas para microscopia
Pinze per microscopia



GRAEFE
10,0 cm, 4"
14-1440-10



GRAEFE
10,0 cm, 4"
14-1441-10



GRAEFE
10,0 cm, 4"
14-1442-10



GRAEFE
10,0 cm, 4"
14-1443-10



GRAEFE
10,0 cm, 4"
14-1444-10



GRAEFE
10,0 cm, 4"
14-1445-10



Uhrmacher Pinzetten, Gefäßdilatoren
Jeweller's Forceps, Vessel Dilators
pinzas de relojeroa, Dilatadores vasculares
Pinze per orologiaio, Dilatatori vascolari



Fig. 3
311,5 cm, 4 1/2"
14-1446-03
0,3 mm x 45°



Fig. 4
411,5 cm, 4 1/2"
14-1447-04
0,3 mm x 90°



Fig. 5
511,5 cm, 4 1/2"
14-1448-05
0,3 mm



Fig. 7
711,5 cm, 4 1/2"
14-1449-07
0,3 mm x 45°



9 mm
11,0 cm, 4 1/4"
14-1450-01



9 mm
11,0 cm, 4 1/4"
14-1451-02



9 mm
11,0 cm, 4 1/4"
14-1452-03



9 mm
11,0 cm, 4 1/4"
14-1453-04
diamantbeschichtet
diamond coated
diamantado
diamantato

Gefäßdilatoren, Atraumatische Pinzetten

Vessel Dilators, Atraumatic Forceps

Dilatadores vasculares, Pinzas atraumáticas

Dilatatori vascolari, Pinze anatomiche atraumatica
0,4 mm 0,3 mm x 45°

0,3 mm



12,0 cm, 4 1/2"
14-1454-12

0,3 mm



13,5 cm, 5 1/2"
14-1455-13

0,4 mm



13,5 cm, 5 1/2"
14-1456-13

0,3 mm x 45°



13,5 cm, 5 1/2"
14-1457-13



DEBAKEY



16,0 cm, 6 1/2"	14-1458-16	14-1459-16	14-1460-16	14-1461-16
20,0 cm, 8"	14-1458-20	14-1459-20	14-1460-20	14-1461-20
24,0 cm, 9 1/2"	14-1458-24	14-1459-24	14-1460-24	14-1461-24
30,0 cm, 12"	14-1458-30	14-1459-30	14-1460-30	14-1461-30



16,0 cm, 6 1/2"	14-1462-16	14-1463-16	14-1464-16
20,0 cm, 8"	14-1462-20	14-1463-20	14-1464-20
24,0 cm, 9 1/2"	14-1462-24	14-1463-24	14-1464-24
30,0 cm, 12"	14-1462-30	14-1463-30	14-1464-30



DEBAKEY



16,0 cm, 6 1/2"	14-1465-16	14-1466-16
20,0 cm, 8"	14-1465-20	14-1466-20
24,0 cm, 9 1/2"	14-1465-24	14-1466-24
30,0 cm, 12"	14-1465-30	14-1466-30



Pinzetten mit Hartmetalleinlagen
 Forceps with tungsten carbide inserts
 Pinzas con bocas de carburo tungsteno
 Pinze con morsi in carburo di tungsteno



STANDARD	
14,5 cm, 5 7/8"	14-1467-14
16,0 cm, 6 1/4"	14-1467-16
18,0 cm, 7"	14-1467-18
20,0 cm, 8"	14-1467-20
25,0 cm, 10"	14-1467-25
30,0 cm, 12"	14-1467-30

STANDARD	
14,0 cm, 5 1/2"	14-1468-14
16,0 cm, 6 1/2"	14-1468-16
18,0 cm, 7"	14-1468-18
20,0 cm, 8"	14-1468-20
26,0 cm, 10"	14-1468-26
30,0 cm, 12"	14-1468-30

STANDARD	
12,5 cm, 5"	14-1469-12
15,0 cm, 6"	14-1469-15

STANDARD	
15,0 cm, 6"	14-1470-15
23,0 cm, 9"	14-1470-23
25,0 cm, 10"	14-1470-25



Pinzetten mit Hartmetalleinlagen
 Forceps with tungsten carbide inserts
 Pinzas con bocas de carburo tungsteno
 Pinze con morsi in carburo di tungsteno



GILLIES
 15,0 cm, 6"
 14-1471-15



MCINDOE
 15,0 cm, 6"
 14-1472-15



GERALD
 17,0 cm, 6 1/2"



14-1474-17

14-1475-17



POTTS-SMITH
 15,0 cm, 6" 14-1473-15
 18,0 cm, 7" 14-1473-18
 20,0 cm, 8" 14-1473-20



BONNEY 17
 5 cm, 6 1/2"
 14-1481-17



CUSHING
 17,5 cm, 6 1/2"

14-1476-17

14-1477-17



CUSHING-TAYLOR
 18,0 cm, 7"
 14-1482-18



ADSON
 17,5 cm, 6 1/2"

12,0 cm, 4 1/2"
 14-1478-12

12,0 cm, 4 1/2"
 14-1479-12

15,0 cm, 6"
 14-1480-15

15,0 cm, 6"
 14-1483-15



Tuchklemmen
Towel Clamps
Pinzas de campo
Pinze per fissare le compresse



SCHAEDEL
9,0 cm, 3 1/2"
14-1484-09



ENGL. MODELL
9,0 cm, 3 1/2"
14-1485-09



JONES
5,0 cm, 2" 14-1486-05
7,0 cm, 2 3/4" 14-1486-07
9,0 cm, 3 1/2" 14-1486-09



JONES
9,0 cm, 3 1/2"
14-1487-09



BACKHAUS
9,0 cm, 3 1/2" 14-1488-09
11,0 cm, 4 1/2" 14-1488-11
13,0 cm, 5" 14-1488-13
15,0 cm, 6" 14-1488-15



mit Schlauch- oder Kabelhalter
with clip for tubing or cable
porta-tubo o porta-cable con
porta-tubo o porta-cavo

11,0 cm, 4 1/2"
14-1489-11



ROEDER
13,0 cm, 5"
14-1490-13



ROEDER
15,0 cm, 5"
14-1491-15



BERNHARD
16,5 cm, 6 1/2"
14-1492-16



13,0 cm, 5"
14-1493-13



LANE
15,0 cm, 6" 14-1495-15
18,0 cm, 7" 14-1495-18
20,0 cm, 8" 14-1495-20



Tuchklemmen, Korn- und Tupferzangen
 Towel Clamps, Sponge and Dressing Forceps
 Pinzas de campo, Pinzas para vendajes y torundas
 pinze per fissare le compresse, Pinze per medicatura e tamponi





Korn- und Tupferzangen
Sponge and Dressing Forceps
Pinzas para vendajes y torundas
Pinze per medicatura e tamponi

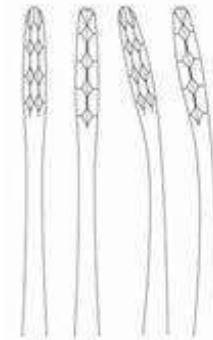

22,0cm, 8 5/8" 14-1506-22 14-1507-22
25,0cm, 9 7/8" 14-1506-25 14-1507-25
27,0cm, 10 5/8" 14-1506-27 14-1507-27



Korn- und Tupferzangen
Sponge and Dressing Forceps
Pinzas para vendajes y torundas
Pinze per medicatura e tamponi



20,0cm, 8"	14-1508-20	14-1509-20
22,0cm, 8 1/2"	14-1508-22	14-1509-22
25,0cm, 9 1/2"	14-1508-25	14-1509-25
27,0cm, 10 1/2"	14-1508-27	14-1509-27

GROSS-MAIER



25,0 cm, 9 1/2"	14-1510-25
-----------------	------------



25,0 cm, 9 1/2"	14-1511-25
-----------------	------------

FOERSTER



18,0cm, 7"	14-1512-18	14-1513-18	14-1514-18	14-1515-18
20,0cm, 8"	14-1512-20	14-1513-20	14-1514-20	14-1515-20
25,0 cm, 9 1/2"	14-1512-25	14-1513-25	14-1514-25	14-1515-25

FOERSTER-BALLENGER



18,0 cm, 7"	14-1516-18
25,0 cm, 9 1/2"	14-1516-25

RAMPLEY

Schlauch klemmen
Tubing Clamps
Pinzas para tubos
Pinze per tubi



PRESBYTERIAN
16,5 cm, 6 1/2" 14-1517-16
18,0 cm, 7" 14-1517-18
20,0 cm, 8" 14-1517-20



BERLIN
14,5 cm, 5 1/2" 14-1518-14



15,0 cm, 6" 14-1519-15
18,0 cm, 7" 14-1519-18
20,0 cm, 8" 14-1519-20



15,0 cm, 6" 14-1520-15
18,0 cm, 7" 14-1520-18
20,0 cm, 8" 14-1520-20

MITBÜGEL

Bulldogklemmen
Bulldog Clamps
Clamps Bulldog
Pinze Bulldog



DIEFFENBACH

3,5 cm, 1 1/2"	14-1521-03	14-1522-03
5,0 cm, 2"	14-1521-05	14-1522-05



HESS
14-1523-01



HESS
14-1524-02



JOHNS-HOPKINS

3,8 cm, 1 1/2"	14-1525-04	14-1526-04
5,0 cm, 2"	14-1525-05	14-1526-05
6,3 cm, 2 1/2"	14-1525-06	14-1526-06
7,6 cm, 3" 9,0	14-1525-07	14-1526-07
cm, 3 1/2"	14-1525-09	14-1526-09



JOHNS-HOPKINS
23,0 cm, 9"
14-1527-23

Bulldogklemmen
Bulldog Clamps
Clamps Bulldog
Pinze Bulldog



mit atraumatischer Riefung
with non-traumatic serration
con bocas atraumáticas con
presa atraumatica

L			
7,5 cm, 3"	14-1528-07	2,5 cm, 1"	
8,5 cm, 3 1/2"	14-1528-08	3,5 cm, 1 1/2"	
10,5 cm, 4 1/8"	14-1528-10	5,0 cm, 2"	
12,0 cm, 4 7/8"	14-1528-12	6,8 cm, 2 3/4"	

DEBAKEY



mit atraumatischer Riefung
with non-traumatic serration
con bocas atraumáticas con
presa atraumatica

L			
7,0 cm, 2 7/8"	14-1529-07	2,5 cm, 1"	
8,0 cm, 3 1/8"	14-1529-08	3,5 cm, 1 1/2"	
10,0 cm, 3 7/8"	14-1529-10	5,0 cm, 2"	
11,5 cm, 4 1/2"	14-1529-12	6,8 cm, 2 3/4"	

DEBAKEY



TITANIUM
3,5 cm, 1 1/2"
Vena_14-1530-35
arteria_14-1531-35



TITANIUM
3,5 cm, 1 1/2"
Vena_14-1532-35
arteria_14-1533-35



TITANIUM
4,0 cm, 1 1/2"
Vena_14-1534-40
Arteria_14-1535-40



TITANIUM
4,0 cm, 1 1/2"
Vena_14-1536-40
arteria_14-1537-40

Bulldogklemmen, Darm- und Gewebefäßzangen
 Bulldog Clamps, Intestinal and Tissue Grasping Forceps
 Clamps Bulldog, Pinzas intestinales y para tejidos
 Pinze Bulldog, Pinze da presa per intestino e tessuti



6,8 cm, 2 ⁷ / ₁₆ "	14-1538-07	3,3 cm, 1 ¹ / ₄ "
9,6 cm, 3 ⁷ / ₁₆ "	14-1538-09	5,0 cm, 2"
11,7 cm, 4 ⁷ / ₁₆ "	14-1538-11	6,9 cm, 2 ⁷ / ₁₆ "

GLOVER



6,5 cm, 2 ¹ / ₂ "	14-1539-06	3,3 cm, 1 ¹ / ₄ "
9,1 cm, 3 ⁷ / ₁₆ "	14-1539-09	5,0 cm, 2"
11,0 cm, 4 ⁷ / ₁₆ "	14-1539-11	6,9 cm, 2 ⁷ / ₁₆ "

GLOVER



CHAPUT
 13,0 cm, 5"
 14-1540-13



TUFFIER
 13,0 cm, 5"
 14-1541-13



COLLIN
 16,0 cm, 6¹/₂"
 14-1542-16



PENNINGTON
 15,5 cm, 6" 14-1543-15
 20,0 cm, 8" 14-1543-20



ATRAUMA



25,0 cm, 9 7/8"
 14-1544-25

Darm- und Gewebefaßzangen
 Intestinal and Tissue Grasping Forceps
 Pinzas intestinales y para tejidos Pinze
 da presa per intestino e tessuti



27,0 cm, 10 1/2"
 14-1544-27



MARTEL
 14,0 cm, 5 1/2"
 14-1545-14



WILLET-MARTEL
 19,0 cm, 7 1/2"
 14-1546-19



Arterienklemmen
Haemostatic Forceps
Pinzas hemostáticas
Pinze emostatiche



PRATT
15,0 cm, 6"
14-1549-15



FERGUSSON



16,0 cm, 6 1/2" 14-1547-16 14-1548-16
20,0 cm, 8" 14-1547-20 14-1548-20



CARREL
10,0 cm, 4"
14-1550-10



TERRIER
10,0 cm, 4"
14-1551-10



KROENLEIN
13,0 cm, 5"
14-1552-13



Arterienklemmen
Haemostatic Forceps
Pinzas hemostáticas
Pinze emostatiche



PEAN

14,0 cm, 5 1/2" 14-1555-14
16,0 cm, 6 1/2" 14-1555-16



BABY-MIXTER
14,0 cm, 5 1/2"

14-1553-01

14-1554-02



SPENCER-WELLS

13,0 cm, 5"	14-1556-13	14-1557-13
15,0 cm, 6"	14-1556-15	14-1557-15
18,0 cm, 7"	14-1556-18	14-1557-18
20,0 cm, 8"	14-1556-20	14-1557-20

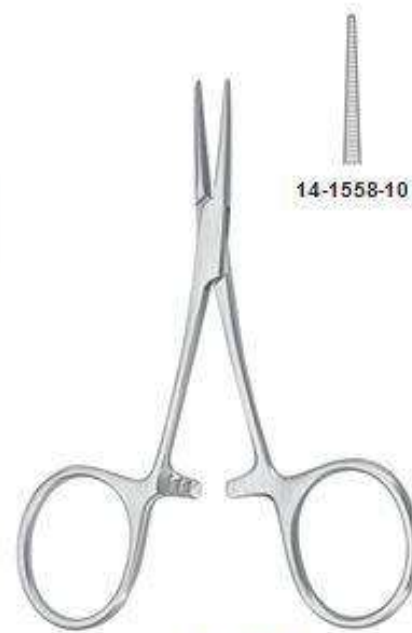

HARTMANN
10,0 cm, 4"

14-1558-10

14-1559-10



Arterienklemmen
Haemostatic Forceps
Pinzas hemostáticas
Pinze emostatiche



PROVICENCE-HOSPITAL
14,0 cm, 5 1/2"



14-1560-14



14-1561-14



HALSTED-MOSQUITO

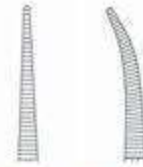

12,5 cm, 5" 14-1562-12 14-1563-12
25,0 cm, 9 1/2" 14-1562-14 14-1563-14

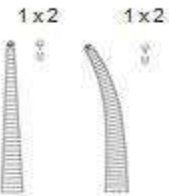

12,5 cm, 5" 14-1564-12 14-1565-12
25,0 cm, 9 1/2" 14-1564-14 14-1565-14



HALSTED-MOSQUITO



18,0 cm, 7" 14-1566-18



18,0 cm, 7" 14-1566-18



21,0 cm, 8 1/4" 14-1567-21



21,0 cm, 8 1/4" 14-1568-21

1 x 2



18,0 cm, 7" 14-1569-18

1 x 2



18,0 cm, 7" 14-1570-18

1 x 2



21,0 cm, 8 1/4" 14-1571-21

1 x 2



21,0 cm, 8 1/4" 14-1572-21

Arterienklemmen
Haemostatic Forceps
Pinzas hemostáticas
Pinze emostatiche



MICRO-MOSQUITO

10,0 cm, 4"	14-1573-10	14-1574-10	14-1575-10	14-1576-10
12,0 cm, 4 1/2"	14-1573-12	14-1574-12	14-1575-12	14-1576-12

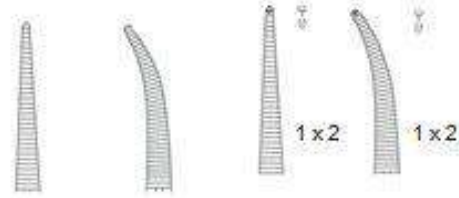

KELLY
14,0 cm, 5 1/2"

14-1577-14



14-1578-14



KELLY-RANKIN
16,0 cm, 6 1/2"

14-1579-16

14-1580-16

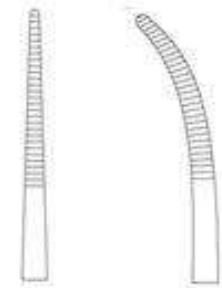

Arterienklemmen
 Haemostatic Forceps
 Pinzas hemostáticas
 Pinze emostatiche



LERICHE
 15,0 cm, 6"



14-1581-15



14-1582-15



14-1583-15

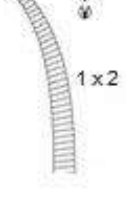

14-1584-15



BABY-OVERHOLT
 13,5 cm, 5 1/2"
 14-1585-14



DANDY
 14,0 cm, 5 1/2"

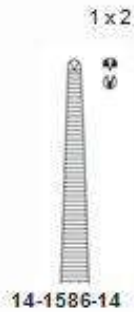

14-1586-14



CRILE
 14,0 cm, 5 1/2"



14-1587-14



14-1588-14



14-1589-14



14-1590-14

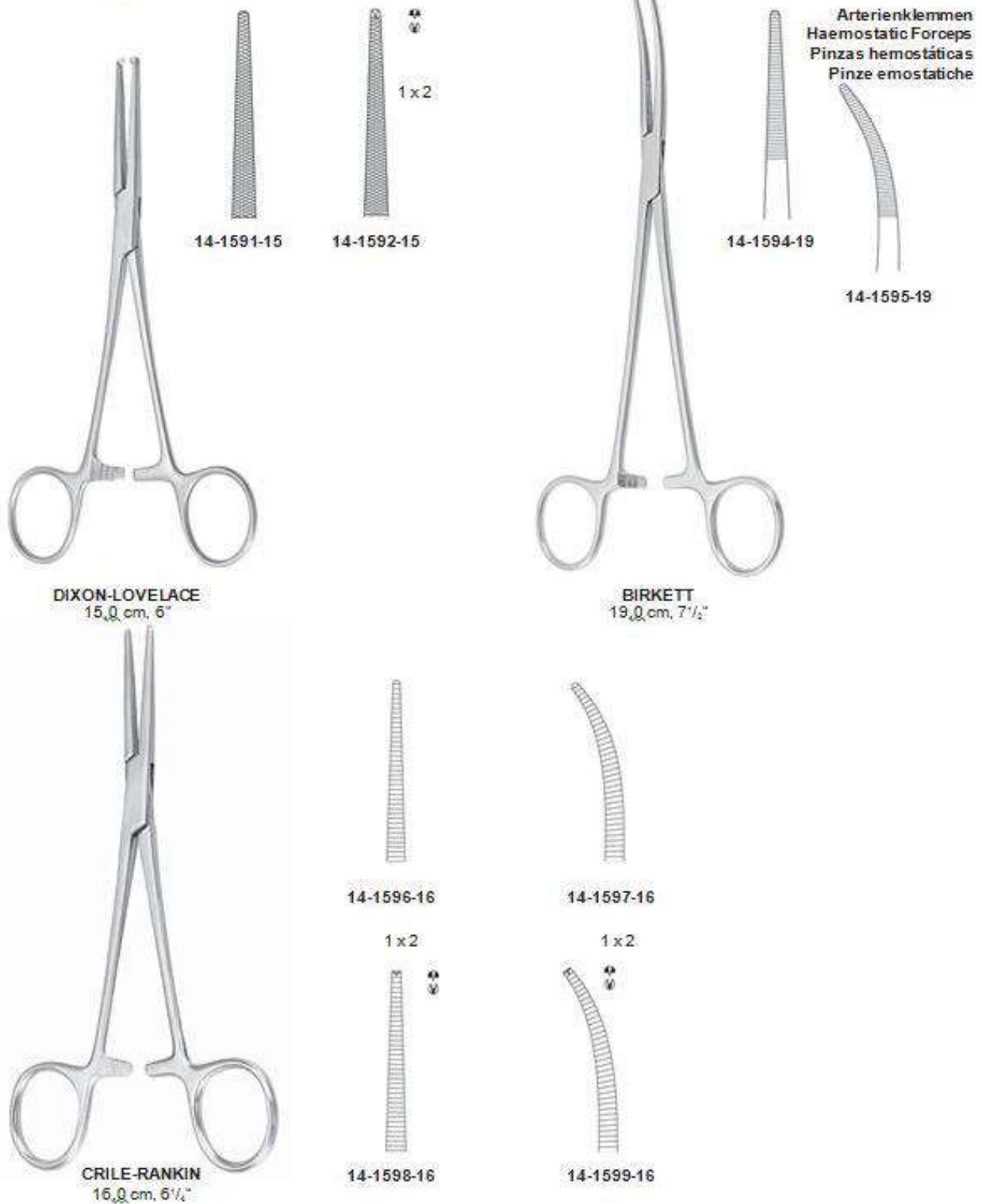



Arterienklemmen
Haemostatic Forceps
Pinzas hemostáticas
Pinze emostatiche



SCHNIDT
19,0 cm, 7 1/2"



14-1600-19



14-1601-19



SCHNIDT-SAWTELL
19,0 cm, 7 1/2"



14-1602-19



14-1603-19



ADSON
18,5 cm, 7 1/4"



14-1604-16



14-1605-16



14-1606-16

1 x 2



14-1607-16

1 x 2



CRAFOORD
24,0 cm, 9 1/2"
14-1608-24



Arterienklemmen
Haemostatic Forceps
Pinzas hemostáticas
Pinze emostatiche



15,0 cm, 6" 14-1609-15 14-1610-15
18,5 cm, 7 1/4" 14-1609-18 14-1610-18

BAINBRIDGE



16,0 cm, 6 1/2" 14-1611-16 14-1612-16
20,0 cm, 8" 14-1611-20 14-1612-20

ROCHESTER-CARMALT



13,0 cm, 5" 14-1613-13 14-1614-13
14,0 cm, 5 1/2" 14-1613-14 14-1614-14
16,0 cm, 6 1/4" 14-1613-16 14-1614-16

PEANDELICATE

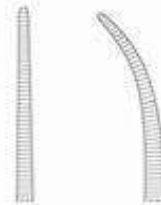

13,0 cm, 5" 14-1615-13 14-1616-13
14,0 cm, 5 1/2" 14-1615-14 14-1616-14
16,0 cm, 6 1/4" 14-1615-16 14-1616-16

KOCHERDELICATE

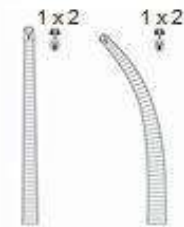

Arterienklemmen
 Haemostatic Forceps
 Pinzas hemostáticas
 Pinze emostatiche



ROCHESTER-PEAN

14,0cm,5 1/2"	14-1617-14	14-1618-14
16,0cm,6 1/4"	14-1617-16	14-1618-16
18,0cm,7"	14-1617-18	14-1618-18
20,0cm,8"	14-1617-20	14-1618-20
22,0cm,8 3/4"	14-1617-22	14-1618-22
24,0cm,9 1/2"	14-1617-24	14-1618-24
26,0cm,10 1/4"	14-1617-26	14-1618-26
30,0cm,12"	14-1617-30	14-1618-30



KOCHER-OCHSNER

14,0cm,5 1/2"	14-1619-14	14-1620-14
16,0cm,6 1/4"	14-1619-16	14-1620-16
18,0cm,7"	14-1619-18	14-1620-18
20,0cm,8"	14-1619-20	14-1620-20
22,0cm,8 3/4"	14-1619-22	14-1620-22
24,0cm,9 1/2"	14-1619-24	14-1620-24
26,0cm,10 1/4"	14-1619-26	14-1620-26
30,0cm,12"	14-1619-30	14-1620-30



BENGOLEA

20,0cm,8"	14-1621-20	14-1622-20	14-1623-20	14-1624-20
26,0cm,10 1/4"	14-1621-26	14-1622-26	14-1623-26	14-1624-26



HEISS
20,0 cm, 8"





Präparier- und Ligaturklemmen
Dissecting and Ligature Forceps
Pinzas de disección y ligaduras
Pinze per preparazioni e legature



BABY-ADSON

14,0 cm, 5 1/2" 18,0 cm, 7"
14-1634-14 14-1635-18



MICRO-ADSON
14,0 cm, 5 1/2"
14-1636-14



BABY-MIXTER
18,0 cm, 7"
14-1637-18



OVERHOLT-MIXTER
21,0 cm, 8 1/4"
14-1638-21



JOHNSHOPKINS
20,0 cm, 8"
14-1639-20



Präparier- und Ligaturklemmen
Dissecting and Ligature Forceps
Pinzas de disección y ligaduras
Pinze per preparazioni e legature

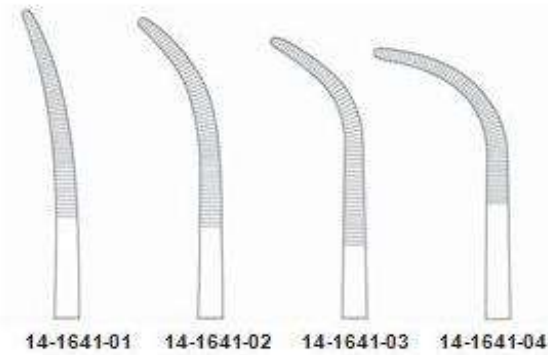
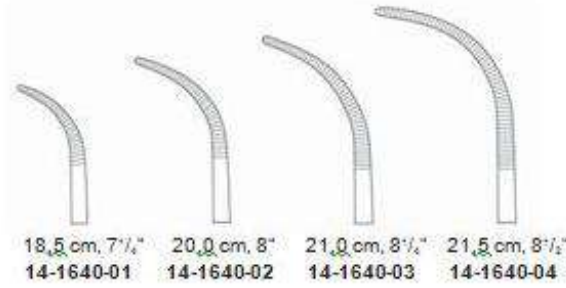



Präparier- und Ligaturklemmen
Dissecting and Ligature Forceps
Pinzas de disección y ligaduras
Pinze per preparazioni e legature



OVERHOLT-GEISSENDOERFER

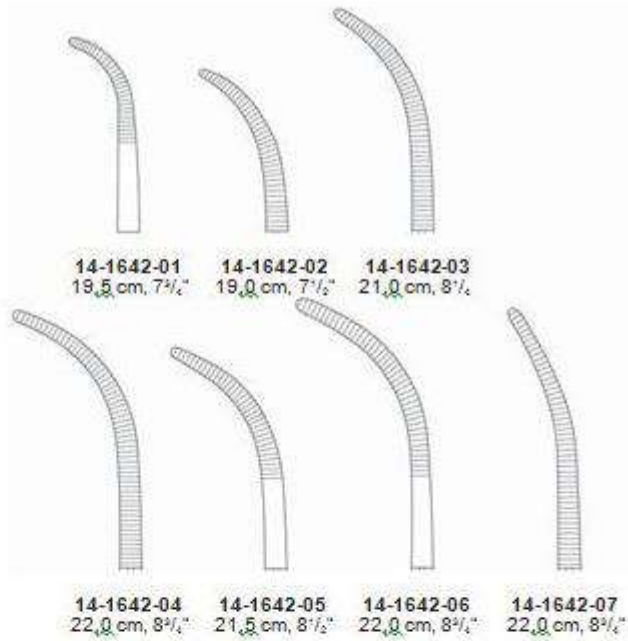

OVERHOLT-GEISSENDOERFER

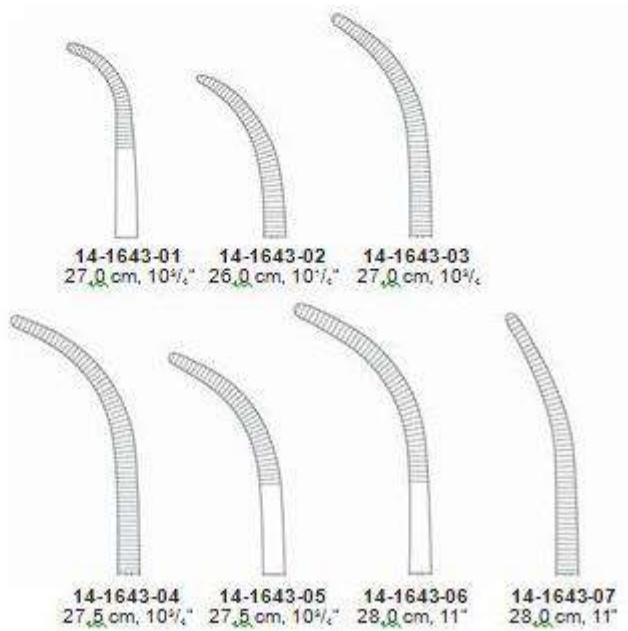



Präparier- und Ligaturklemmen
Dissecting and Ligature Forceps
Pinzas de disección y ligaduras
Pinze per preparazioni e legature

21,0 cm, 8 1/2," 14-1644-21 14-1645-21 14-1646-21 14-1647-21
26,0 cm, 10 1/2," 14-1644-26 14-1645-26 14-1646-26 14-1647-26



19,0cm, 7 1/2," 14-1648-19 14-1649-19 14-1650-19
22,0cm, 8 1/2," 14-1648-22 14-1649-22 14-1650-22
24,0 cm, 9 1/2," 14-1648-24 14-1649-24 14-1650-24



Präparier- und Ligaturklemmen
Dissecting and Ligature Forceps
Pinzas de disección y ligaduras
Pinze per preparazioni e legature



18,0cm, 7"	14-1651-18
22,0cm, 8 1/2"	14-1651-22
25,0cm, 9 1/2"	14-1651-25
28,0 cm, 11"	14-1651-28

MINI-GEMINI



14,0 cm, 5 1/2"	14-1652-14
16,0 cm, 6 1/2"	14-1652-16
18,0 cm, 7"	14-1652-18
20,0 cm, 8"	14-1652-20
23,0 cm, 9"	14-1652-23
25,0 cm, 9 1/2"	14-1652-25
28,0 cm, 11"	14-1652-28

GEMINI



20,0 cm, 8"	14-1653-20
24,0cm, 9 1/2"	14-1653-24
28,0 cm, 11"	14-1653-28

KANTROWITZ



19,0cm, 7 1/2"	14-1654-19
21,0cm, 8 1/2"	14-1654-21
24,0 cm, 9 1/2"	14-1654-24

WIKSTROEM



Präparier- und Ligaturklemmen
Dissecting and Ligature Forceps
Pinzas de disección y ligaduras
Pinze per preparazioni e legature



MIXTER
15,5 cm, 6" 14-1655-15
19,0 cm, 7 1/2" 14-1655-19



MIXTER-O' SHAUGNESSY
15,5 cm, 6" 14-1656-15
19,0 cm, 7 1/2" 14-1656-19



MIXTER
22,0 cm, 8 3/4" 14-1657-22



MIXTER
23,0 cm, 9" 14-1473-23



ZENKER



14-1658-01, 14-1659-02



ZENKER

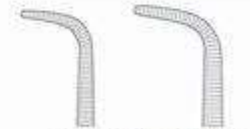

14-1660-18 14-1661-28



Präparier- und Ligaturklemmen
Dissecting and Ligature Forceps
Pinzas de disección y ligaduras
Pinze per preparazioni e legature



LAWRENCE
27,5 cm, 10 3/4"
14-1664-28



14-1662-21, 14-1663-21

HOSEMANN
21,0 cm, 8 1/4"



DESJARDINS
21,0 cm, 8 1/4"
14-1665-21



MIXTER
22,0 cm, 8 3/4" 14-1666-22
25,0 cm, 9 7/8" 14-1666-25
28,0 cm, 11" 14-1666-28



LAHEY
19,0 cm, 7 1/2" 14-1667-19
23,0 cm, 9" 14-1667-23



LOWER
18,0 cm, 7"
14-1668-18

Präparier- und Ligaturklemmen
 Dissecting and Ligature Forceps
 Pinzas de disección y ligaduras
 Pinze per preparazioni e legature



MCQUIGG-MIXTER

22,0 cm, 8¹/₂"
 14-1671-22



GRAY

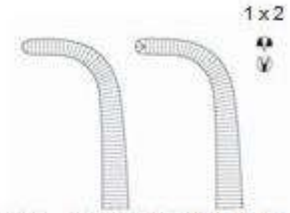

22,0 cm, 8 ¹ / ₂ "	14-1669-22	14-1670-22
23,0 cm, 9"	14-1669-23	14-1670-23



CRAFOORD-SELLORS
 24,0 cm, 9¹/₂" 14-1675-24

22,0 cm, 8 ¹ / ₂ "	23,0 cm, 9"	24,0 cm, 9 ¹ / ₂ "
14-1672-22	14-1673-23	14-1674-24



FINOCCHIETTO



Gallenkanal- und Nierenstielklemmen
 Gall Duct and Kidney Pedicle Clamps
 Pinzas-clamps para pedúnculo renal
 Pinze per peduncoli renali



GUYON

20,0 cm, 8"	14-1676-20
22,0 cm, 8 1/2"	14-1676-22
24,0 cm, 9 1/2"	14-1676-24



GUYON

23,0 cm, 9"	14-1677-23
-------------	------------



GUYON

23,0 cm, 9"	14-1678-23
-------------	------------

24,0 cm, 9 1/2"	14-1679-24
-----------------	------------



STILLE

23,0 cm, 9"	14-1680-23
-------------	------------



Gallenkanal- und Nierenstielklemmen, Bronchusklemmen
 Gall Duct and Kidney Pedicle Clamps, Bronchus Forceps
 Pinzas-clamps para pedúnculo renal, Pinzas-clamps para bronquios
 Pinze per peduncoli renali, Pinze per legature





Bronchusklemmen, Peritoneumklemmen, Hysterektomieklemmen
 Bronchus Forceps, Peritoneum Forceps, Hysterectomy Forceps
 Pinzas-clamps para bronquios, Pinzas-clamps para peritoneo y para histerectomia
 Pinze per legature, Pinze per peritoneo e per isterectomia



PRICE-THOMAS
 22,0 cm, 8 1/2"



14-1687-01



14-1688-02



14-1689-01



14-1690-02



BABY-MIKULICZ
 14,0 cm, 5 1/2"
 14-1691-14

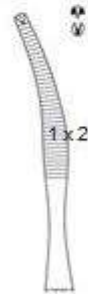

1x2



MIKULICZ
 18,0 cm, 7"
 14-1692-18



1x2



MIKULICZ
 20,0 cm, 8"
 14-1693-20

SEMB
 24,0 cm, 9 1/2"



1x2

Peritoneumklemmen, Hysterektomieklemmen
 Peritoneum Forceps, Hysterectomy Forceps
 Pinzas-clamps para peritoneo y para histerectomía
 Pinze per peritoneo e peristerectomia





Hysterektomieklappen
Hysterectomy Forceps
Pinzas-clamps para histerectomia
Pinze per isterectomia





Hysterektomieklemmen
Hysterectomy Forceps
Pinzas-clamps para histerectomia
Pinze per isterectomia





Hysterektomieklemmen
Hysterectomy Forceps
Pinzas - clamps para hysterectomia
Pinze per isterectomia



21,0 cm, 8 1/2"	14-1713-21	14-1714-21
23,0 cm, 9"	14-1713-23	14-1714-23

Nadelhalter
Needle Holders
Porta-agujas
Portaghi

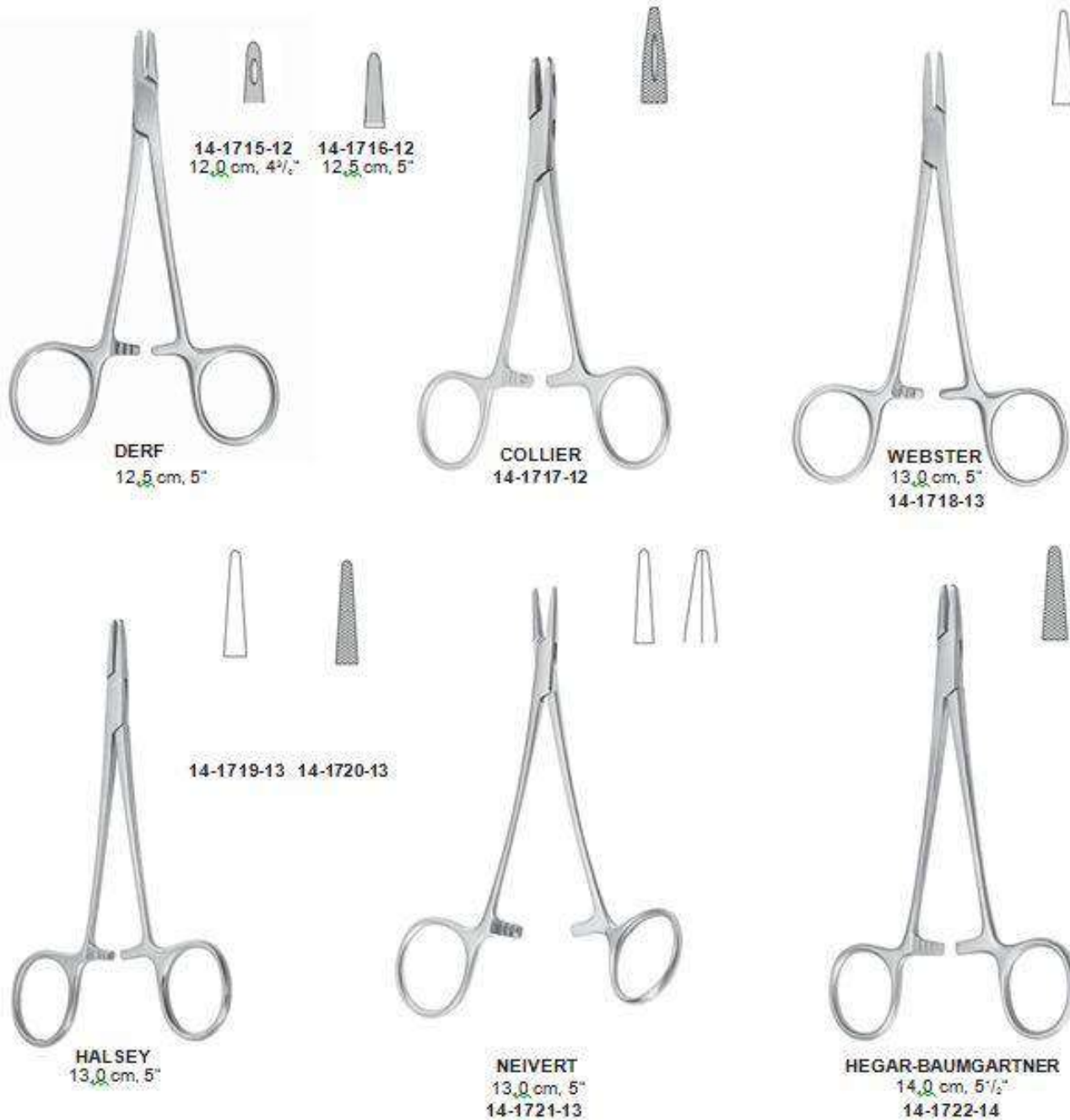

Nadelhalter
Needle Holders
Porta-agujas
Portaghi





Nadelhalter
Needle Holders
Porta-agujas
Portaghi



MAYO-HEGAR



14-1729-14



14-1729-16



14-1729-18



14-1729-20



14-1729-24



14-1729-26



14-1729-30



MAYO-HEGAR-DELICATE

15,0 cm, 6"
14-1731-15



14-1730-16
16,0 cm, 6 1/2"



14-1730-18
18,0 cm, 7"



14-1730-20
20,0 cm, 8"



LAWRENCE





HEANEY
21,0 cm, 8 1/2"
14-1732-21



JAMISON
23,5 cm, 9 1/4"
14-1733-23



Nadelhalter
Needle Holders
Porta-agujas
Portaghi

MASSON
27,0 cm, 10 1/2"
14-1734-27



FINOCCHIETTO
27,0 cm, 10 1/2"
14-1735-27



WANGENSTEEN
27,0 cm, 10 1/2"
14-1736-27



JOHNSON
27,0 cm, 10 1/2"
14-1737-27



Nadelhalter
Needle Holders
Porta-agujas
Portaghi



STRATTE
23,0 cm, 9"
14-1738-23



OLSEN-HEGAR
17,0 cm, 6 1/2"
14-1739-17



OLSEN-HEGAR
14,0 cm, 5 1/2"
14-1740-14



OLSEN-HEGAR
18,0 cm, 7"
14-1742-18



14,0 cm, 5 1/2"
14-1741-14



18,0 cm, 7"
14-1741-18



TOENNIS



Nadelhalter
Needle Holders
Porta-agujas
Portaghi



14-1743-14
14,0 cm, 5 1/2"

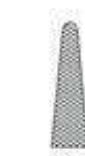

14-1743-17
17,0 cm, 6 1/2"



14-1743-20
20,0 cm, 8"



14-1744-17
17,0 cm, 6 1/2"



14-1744-20
20,0 cm, 8"



LICHTENBERG
20,0 cm, 8"
14-1746-20



14-1745-14
14,0 cm, 5 1/2"



14-1745-17
17,0 cm, 6 1/2"



Nadelhalter, Mikro-Nadelhalter
Needle Holders, Micro Needle Holders
Porta-agujas, Micro Porta-agujas
Portaghi, Micro Portaghi



14-1747-14
14,0 cm, 5 1/2"



14-1747-17
17,0 cm, 6 1/2"



14-1747-20
20,0 cm, 8"



14-1748-10



14-1749-10

MATHIEU-KOCHER

BARRAQUER-TROUTMAN
10,0 cm, 4"



14-1750-10 14-1751-10



BARRAQUER
13,5 cm, 5 1/2"
14-1752-13



GOMEL
14,0 cm, 5 1/2"
14-1753-14

BARRAQUER



Mikro-Nadelhalter
Micro Needle Holders
Micro Porta-agujas
Micro Portaghi



14-1754-18

ohne Sperre
without ratchet
sin cremallera
senza cremagliera

18,5 cm, 7 1/2"



14-1755-18



14-1757-18

mit Sperre
with ratchet
con cremallera
con cremagliera

18,5 cm, 7 1/2"



14-1758-18



14-1759-14

14-1761-14

mit Sperre
with ratchet
con cremallera
con cremagliera

CASTROVIEJO
14,5 cm, 5 1/2"



14-1760-14



14-1762-14



14-1763-18

14-1765-18

mit Sperre
with ratchet
con cremallera
con cremagliera

CASTROVIEJO
18,0 cm, 7"



14-1764-18



14-1766-18



Mikro-Nadelhalter
Micro Needle Holders
Micro Porta-agujas
Micro Portaghi

0,4 mm



gerade, ohne Sperre
straight, without ratchet
recta, sin cremallera
retta, senza cremagliera

14,0 cm, 5 1/2"
14-1767-14

0,4 mm



gebogen, ohne Sperre
curved, without ratchet
curva, sin cremallera
curva, senza cremagliera

14,0 cm, 5 1/2"
14-1768-14

0,4 mm



14,0 cm, 5 1/2"
14-1769-14

0,5 mm



gebogen, ohne Sperre
curved, without ratchet
curva, sin cremallera
curva, senza cremagliera

Ø 10 mm

14,0 cm, 5 1/2"
14-1770-14

0,5 mm



gebogen, ohne Sperre
curved, without ratchet
curva, sin cremallera
curva, senza cremagliera

14,0 cm, 5 1/2"
14-1771-14

Ø 10 mm

0,4 mm



gebogen, ohne Sperre
curved, without ratchet
curva, sin cremallera
curva, senza cremagliera

13,0 cm, 5"
14-1772-13

Ø 8 mm

0,4 mm



gebogen, ohne Sperre
curved, without ratchet
curva, sin cremallera
curva, senza cremagliera

13,0 cm, 5"
14-1773-13

Ø 8 mm



Nadelhalter mit Hartmetalleinlagen Needle
 Holders with tungsten carbide inserts
 Porta-agujas con bocas de carburo tungsteno
 Portaghi con morsi in carburo di tungsteno



KALT
 13,5 cm, 5 1/2"
 14-1776-14



DIETHRICH

16,0 cm, 5 1/2"	14-1775-16
18,0 cm, 7"	14-1775-18
20,0 cm, 8"	14-1775-20
23,0 cm, 9"	14-1775-23
26,0 cm, 10 1/2"	14-1775-26



WEBSTER
 13,0 cm, 5"
 14-1777-13



DERF
 12,0 cm, 4 1/2"
 14-1780-12



HEGAR-BAUMGARTNER

14-1778-12
 12,5 cm, 5"

14-1779-14
 14,0 cm, 5 1/2"



WEBSTER
 13,0 cm, 5"
 14-1781-13



Nadelhalter mit Hartmetalleinlagen Needle
Holders with tungsten carbide inserts
Porta-agujas con bocas de carburo
tungsteno Portaghi con morsi in carburo di
tungsteno

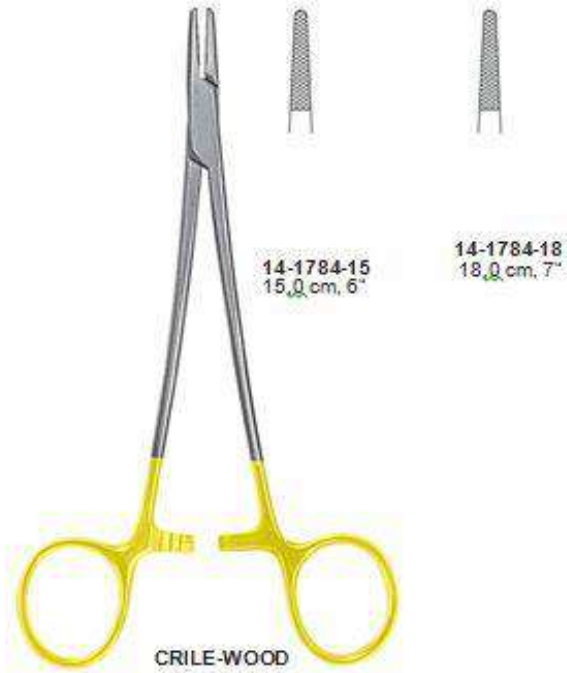



14-1786-16
16,0 cm, 6 1/2"



14-1786-18
18,0 cm, 7"

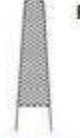

14-1786-20
20,0 cm, 8"



14-1786-24
24,0 cm, 9 1/2"



14-1786-26
26,0 cm, 10 1/2"



14-1786-30
30,0 cm, 12"

Nadelhalter mit Hartmetalleinlagen.
Needle Holders with tungsten carbide inserts
Porta-agujas con bocas de carburo tungsteno
Portaghi con morsi in carburo di tungsteno



14-1787-20
20,0 cm, 8"



14-1787-24
24,0 cm, 9 1/2"



14-1787-26
26,0 cm, 10 1/2"

Nadelhalter mit Hartmetalleinlagen
 Needle Holders with tungsten carbide inserts
 Porta-agujas con bocas de carburo tungsteno
 Portaghi con morsi in carburo di tungsteno

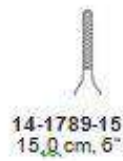
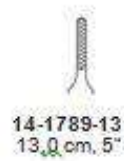
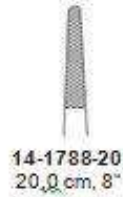

Nadelhalter mit Hartmetalleinlagen Needle Holders with tungsten carbide inserts
 Porta-agujas con bocas de carburo tungsteno Portaghi con morsi in carburo di tungsteno

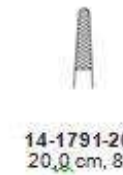
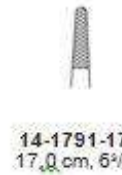
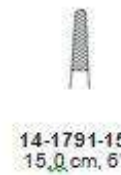
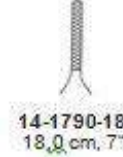
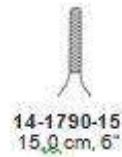
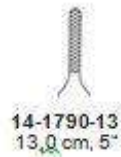



Nadelhalter mit Hartmetalleinlagen
Needle Holders with tungsten carbide inserts
Porta-agujas con bocas de carburo tungsteno
Portaghi con morsi in carburo di tungsteno

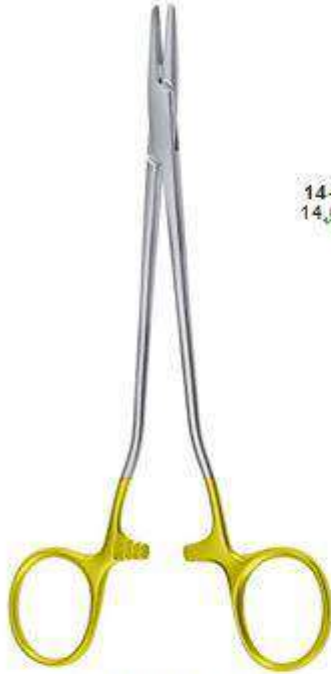

MAYO-HEGAR(HEANEY)



FINOCCHIETTO
27,0 cm, 10 1/2"
14-1793-27



MASSON
27,0 cm, 10 1/2"
14-1794-27



WANGENSTEEN
27,0 cm, 10 1/2"
14-1795-27

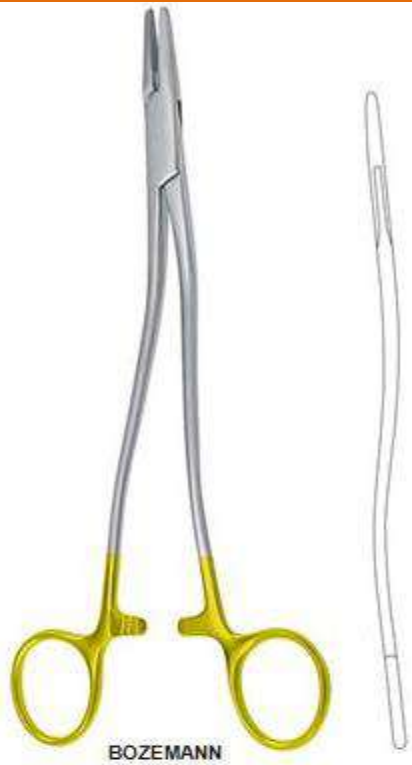

BOZEMANN

Nadelhalter mit Hartmetalleinlagen Needle
Holders with tungsten carbide inserts
Porta-agujas con bocas de carburo tungsteno
Portaghi con morsi in carburo di tungsteno



14-1796-20
20,0 cm, 8"



14-1796-24
24,0 cm, 9 1/4"



14-1796-26
26,0 cm, 10 1/4"



HEGAR



14-1797-20
20,0 cm, 8"



14-1797-24
24,0 cm, 9 1/4"



BARRY STERNAL



14-1798-15
15,0 cm, 6"



14-1798-20
20,0 cm, 8"

Nadelhalter mit Hartmetalleinlagen
 Needle Holders with tungsten carbide inserts
 Porta-agujas con bocas de carburo tungsteno
 Portaghi con morsi in carburo di tungsteno

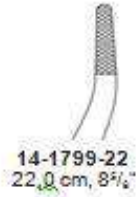



MATHIEU-KOCHER



14-1803-14
14,0 cm, 5 1/2"

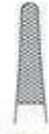

14-1803-17
17,0 cm, 6 1/2"



14-1803-20
20,0 cm, 8"

Nadelhalter mit Hartmetalleinlagen
Needle Holders with tungsten carbide inserts
Porta-agujas con bocas de carburo tungsteno
Portaghi con morsi in carburo di tungsteno



MATHIEU



14-1804-14
14,0 cm, 5 1/2"



14-1804-17
17,0 cm, 6 1/2"



14-1804-20
20,0 cm, 8"

Nadelhalter mit Hartmetalleinlagen
 Needle Holders with tungsten carbide inserts
 Porta-agujas con bocas de carburo tungsteno
 Portaghi con morsi in carburo di tungsteno



LICHTENBERG



14-1805-17
17,0 cm, 6³/₄"

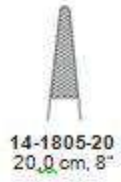

14-1805-20
20,0 cm, 8"



MATHIEU

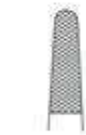

14-1806-17
17,0 cm, 6³/₄"



14-1806-20
20,0 cm, 8"



14-1806-23
23,0 cm, 9"

Nadelhalter mit Hartmetalleinlagen Needle
 Holders with tungsten carbide inserts
 Porta-agujas con bocas de carburo tungsteno
 Portaghi con morsi in carburo di tungsteno



ZWEIFEL



14-1807-20
 20,0 cm, 8"



14-1807-23
 23,0 cm, 9"



LANGENBECK



14-1808-18
 18,0 cm, 7"



14-1808-20
 20,0 cm, 8"



14-1808-23
 23,0 cm, 9"

14-1809-18
 18,0 cm, 7"

14-1809-20
 20,0 cm, 8"

14-1809-23
 23,0 cm, 9"

Nadelhalter mit Hartmetalleinlagen
 Needle Holders with tungsten carbide inserts
 Porta-agujas con bocas de carburo tungsteno
 Portaghi con morsi in carburo di tungsteno

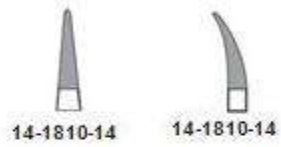
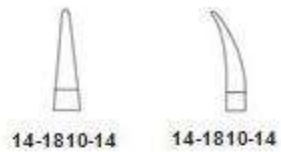

mit Sperre with
 ratchetton
 cremallera
 сщп cremagliera

CASTROVIEJO
 14,5 cm, 5 1/2"

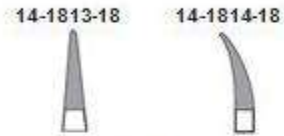
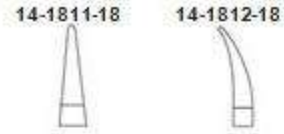

mit Sperre with
 ratchetton
 cremallera
 сщп cremagliera

CASTROVIEJO
 18,0 cm, 7"

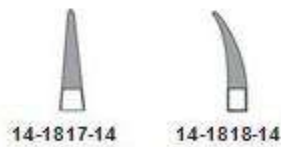
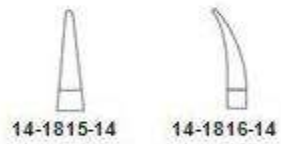

mit Sperre with
 ratchetton
 cremallera
 сщп cremagliera

BARRAQUER
 14,5 cm, 5 1/2"



HEPPSCHEIDEL
 18,0 cm, 7"
 14-1819-18



REVERDIN-Nadeln
REVERDIN Needles
Agujas de REVERDIN
Aghi di REVERDIN



REVERDIN
14,0 cm, 5 1/2"



14-1820-01



14-1820-02



14-1820-03



14-1820-04



REVERDIN



19,5 cm, 7 1/2" 14-1821-01 14-1821-02 14-1821-03 14-1821-04
22,5 cm, 8 7/8" 14-1822-01 14-1822-02 14-1822-03 14-1822-04



Unterbindungsnadeln
Ligature Needles
Agujas para ligaduras
Aghi per legatura

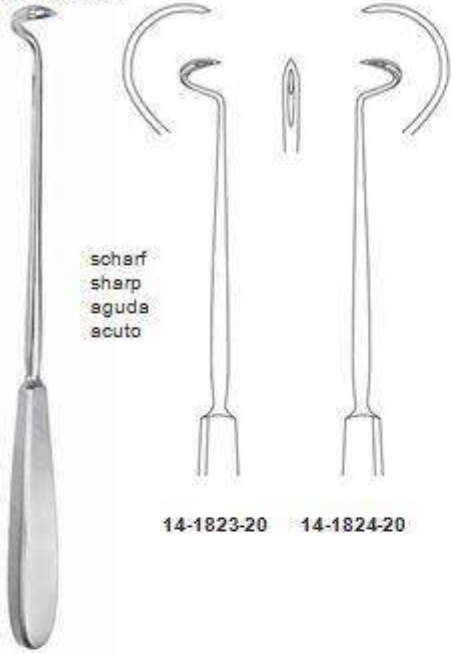

scharf
sharp
aguda
acuto

14-1823-20 14-1824-20

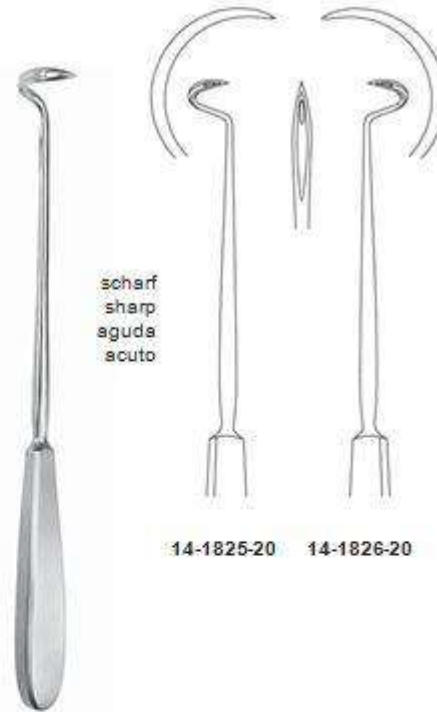

scharf
sharp
aguda
acuto

14-1825-20 14-1826-20

DE SCHAMPS
20,0 cm, 8"

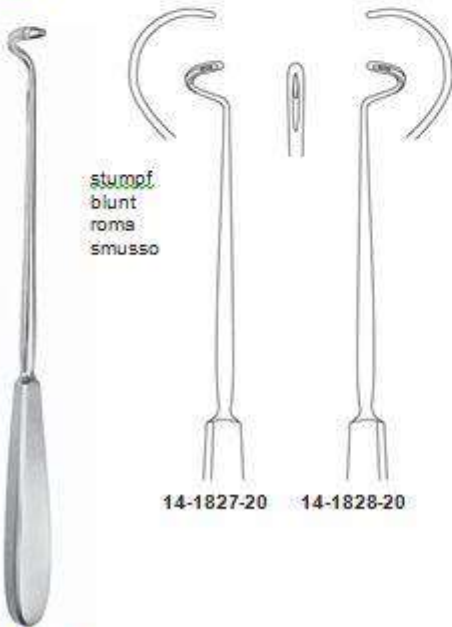

stumpf
blunt
roma
smusso

14-1827-20 14-1828-20

DE SCHAMPS
20,0 cm, 8"

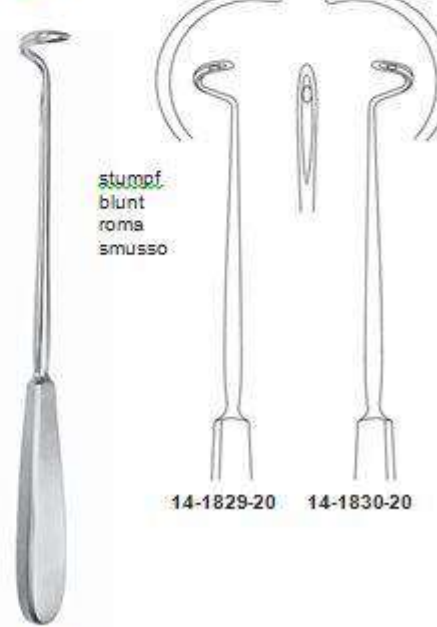

stumpf
blunt
roma
smusso

14-1829-20 14-1830-20

DE SCHAMPS
20,0 cm, 8"

DE SCHAMPS
20,0 cm, 8"



scharf
sharp
aguda
acuto

21,0 cm, 8 1/4" 14-1831-21 14-1832-21
27,0 cm, 10 5/8" 14-1831-27 14-1832-27

DE SCHAMPS

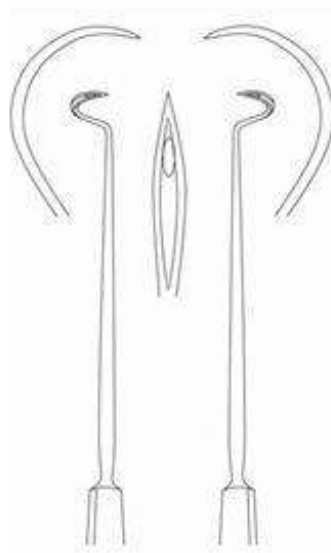

stumpf
blunt
roma
smusso

21,0 cm, 8 1/4" 14-1833-21 14-1834-21
27,0 cm, 10 5/8" 14-1833-27 14-1834-27

DE SCHAMPS

Unterbindungsnadeln
Ligature Needles
Agujas para ligaduras
Aghi per legatura

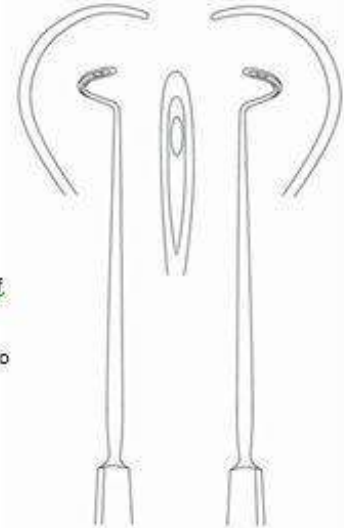

20,0 cm, 8"
14-1835-20

biegsam
malleable
maleable
malleabile



COOPER
19,0 cm, 7 1/2"
14-1836-19



COOPER
20,0 cm, 8"
14-1837-20



SYME
15,0 cm, 6"
14-1838-15





Unterbindungsnadeln
Ligature Needles
Agujas para ligaduras
Aghi per legatura



14-1839-01



14-1839-02



14-1839-03



BRUNNER
25,0 cm, 9 7/8"

14-1840-25

KOCHER19,
9 cm, 7 1/8"



14-1841-01



14-1841-02



BRUNNER
30,0 cm, 11 7/8"

14-1842-21



SCHMIEDEN
21,0 cm, 8 1/4"

14-1842-21



Unterbindungsnaedeln
Ligature Needles
Agujas para ligaduras
Aghi per legatura



14-1843-01



14-1843-02



14-1843-03

YOUNG-HRYNTSCHAK
24,0 cm, 9 1/2"
LN-1844-24



DELAROZA
12,0 cm, 4 1/2"
14-1845-01



DELAROZA
12,0 cm, 4 1/2"
14-1846-02



JAKOBI
14,0 cm, 5 1/2"
14-1847-14



HESSEBERG
15,0 cm, 6"
14-1848-15



KRONECKER
15,0 cm, 6"
14-1849-01

Unterbindungsnadeln
 Ligature Needles
 Aguja para ligaduras
 Aghi per legatura



KRONECKER
 15,0 cm, 6"
 14-1850-02



TRELAT
 23,0 cm, 9"
 14-1851-23



CLAUS
 23,0 cm, 9"
 14-1852-23



HURD
 21,0 cm, 8 1/2"
 14-1853-01



HURD
 21,0 cm, 8 1/2"
 14-1854-02



NAGER
 24,0 cm, 9 1/2"
 14-1855-24



CLAUS-EICKEN
 23,0 cm, 9"
 14-1856-23



FALK
 24,0 cm, 9 1/2"
 14-1857-01



FALK
 24,0 cm, 9 1/2"
 14-1858-02

Führungshohlsonden
Ligature Conductors
Sondas conductoras
Sonde conduttrici



BRUNNER
30,0 cm, 11³/₄"



14-1859-01

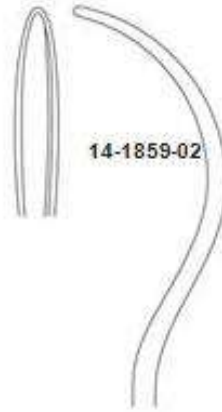

14-1859-02



14-1859-03



14-1859-04



Führungshohlsonden
Ligature Conductors
Sondas conductoras
Sonde conduttrici



PAYR
22,0 cm, 8¹/₂"
14-1860-22



PAYR
22,0 cm, 8¹/₂"
14-1861-22



mit Loch
with hole
con foro
con ago

SCHMIEDEN-PAYR
19,0 cm, 7¹/₂"
14-1862-19



ohne Loch
without hole
sin foro
senza ago

SCHMIEDEN
19,0 cm, 7¹/₂"
14-1863-19



KÖNIG
19,5 cm, 7¹/₂"
14-1864-03



KÖNIG
19,5 cm, 7¹/₂"
14-1865-05



KÖNIG
19,5 cm, 7¹/₂"
14-1866-07

Führungshohlsonden
 Ligature Conductors
 Sondas conductoras
 Sonde conduttrice



KIRSCHNER



25,5 cm, 10"
 14-1867-25



28,0 cm, 11"
 14-1867-28



BRUNNER-FERROZELL
 18,0 cm, 7" 14-1868-18
 27,0 cm, 10 1/2" 14-1868-27



KOCHER

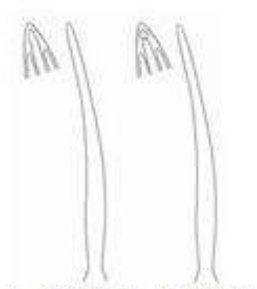

15,0 cm, 6" 14-1869-15 14-18/15-15
 18,0 cm, 7" 14-1869-16 LN-1870-16



16,0 cm, 6 1/2"
 14-1871-18

Nahtinstrumente
Suture Instruments
Instrumentos para sutura
Strumenti per sutura



MOD. WIEN
23,5 cm, 9 1/2"
14-1872-23



BOZEMANN
21,0 cm, 8 1/2"
14-1873-21



23,0 cm, 9"
14-1874-23



MICHEL
12,0 cm, 4 1/2"
14-1875-12



COLLIN
13,0 cm, 5"
14-1876-13



RICHTER-HEATH
14,0 cm, 5 1/2"
14-1877-14



WACHENFELDT
12,5 cm, 5"
14-1878-01



HEGENBARTH
12,5 cm, 5"
14-1879-12



Nahtinstrumente
Suture Instruments
Instrumentos para sutura
Strumenti per sutura



MICHEL
12,0 cm, 4 1/2"
14-1880-12



LANGE
10,0 cm, 4"
14-1881-10



CHILDE
18,0 cm, 7"
14-1882-01



CHILDE
18,0 cm, 7"
14-1883-02



MICHEL

- 14-1884-08 7,5x1,75mm
- 14-1884-11 11,0x2,0mm
- 14-1884-12 12,0 x 3,0 mm
- 14-1884-14 14,0x3,0mm
- 14-1884-16 16,0x3,0mm
- 14-1884-18 18,0 x 3,0 mm
- 14-1884-20 20,0 x 3,0 mm
- 14-1884-22 22,0 x 3,0 mm



CLIP-SET
056-558-00
bestehend aus, consisting of, compuesto de, composto da

- 1x 14-1885-12
- 1x 14-1886-12
- 50 x 14-1887-14
- 1 x 14-1888-01



Dura- und Hauthäkchen
Dura and Skin Retractors
Gancho para piel y dura-madre
Unico per pelle e dura-madre



GILLIES
18,0 cm, 7"



KILNER
15,0 cm, 6"
14-1891-15



FRAZIER
13,0 cm, 5"
14-1892-13



O'CONNOR
16,0 cm, 6 1/4"
14-1893-16

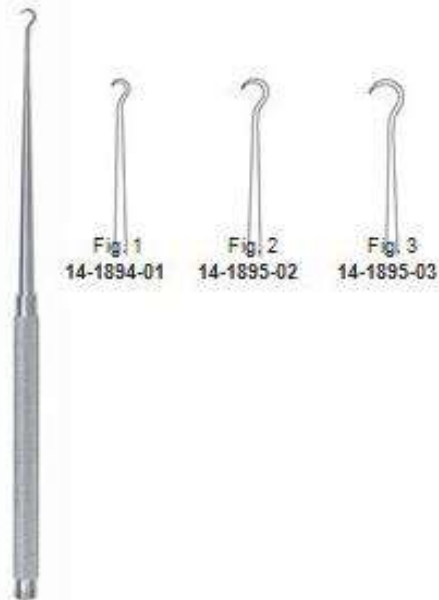

KLEINERT-KUTZ
16,0 cm, 6 1/4"



JOSEPH
16,0 cm, 6 1/4"
14-1898-16



GRAEFE
16,0 cm, 6 1/4"

Dura- und Hauthäkchen
 Dura and Skin Retractors
 Gancho para piel y dura-madre
 Unico per pelle e dura-madre

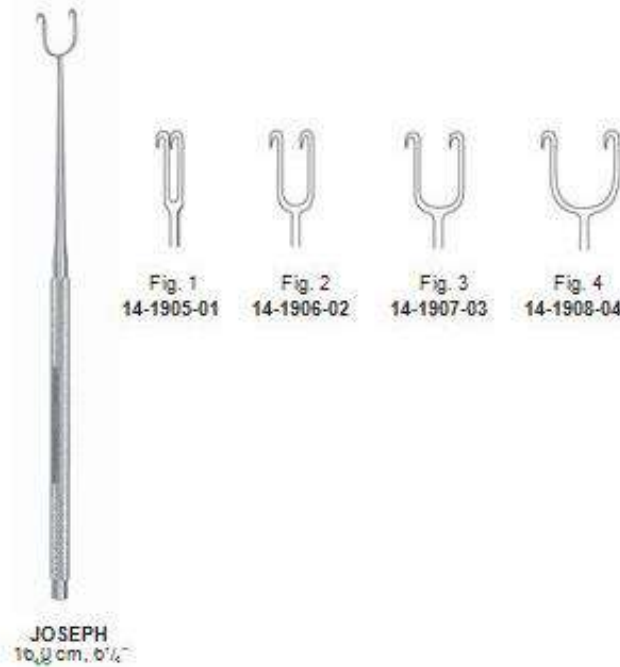

Wundhaken
Retractors
Separadores
Divaricatori

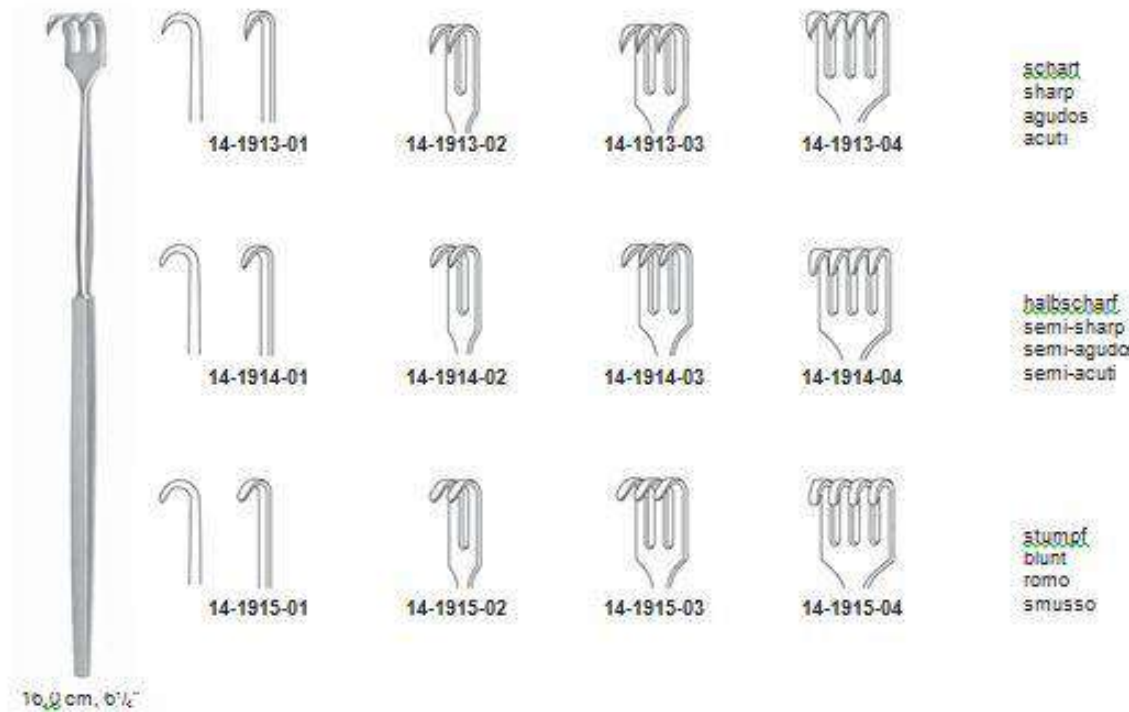
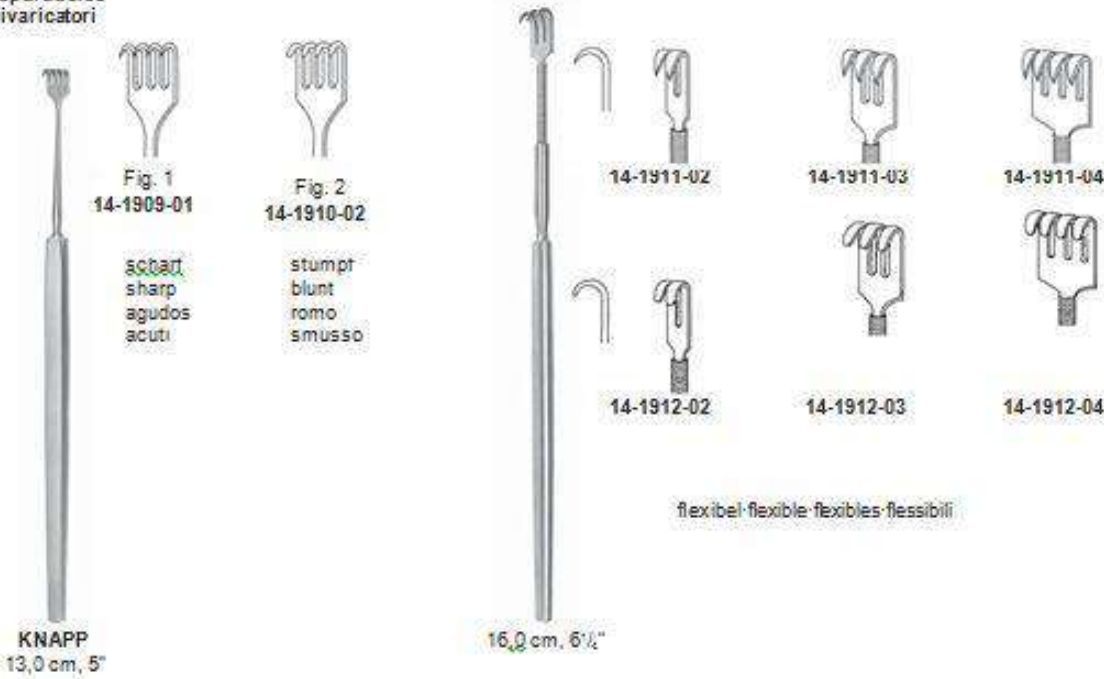



16,0 cm, 6 1/4"



14-1916-01



14-1916-02



14-1916-03



14-1916-04



14-1917-01



14-1917-02



14-1917-03

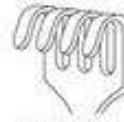

14-1917-04

Wundhaken
Retractors
Separadores
Divaricatori

scharf
sharp
agudos
acuti

stumpf
blunt
romo
smusso



CUSHING
19,0 cm, 7 1/2"



Fig. 1
14-1918-01



Fig. 2
14-1918-02



LANGENBECK-GREEN
16,0 cm, 6 1/4"



16 x 6 mm
14-1919-01



24 x 6 mm
14-1919-02

Wundhaken
Retractors
Separadores
Divaricatori



MEYERDING
18,0 cm, 7"



18 x 7 mm
14-1920-01



16 x 5 mm
14-1920-02



7 x 4 mm
14-1920-03



14 x 8 mm
14-1923-16



10 x 3 mm
14-1921-04



7 x 4 mm
14-1921-05



4 x 10 mm
14-1921-06



16,0 cm, 6 1/2"



SENN-GREEN
15,0 cm, 6"



10 x 6 mm
14-1924-10



20 x 6 mm
14-1924-20



MINI-LANGENBECK
16,0 cm, 6 1/2"



10 x 6 mm
14-1925-01



17 x 5 mm
14-1925-02



20 x 6 mm
14-1926-03



22 x 8 mm
14-1926-04

Wundhaken
Retractors
Separadores
Divaricatori



RAGNELL-DAVIS
14,0 cm, 5 1/2"
14-1927-14



RAGNELL
15,0 cm, 6"
14-1928-15



BABYSENN-MILLER
15,0 cm, 6"



14-1929-15

14-1930-15

scharf
sharp
agudos
acuti

stumpf
blunt
romo
smusso

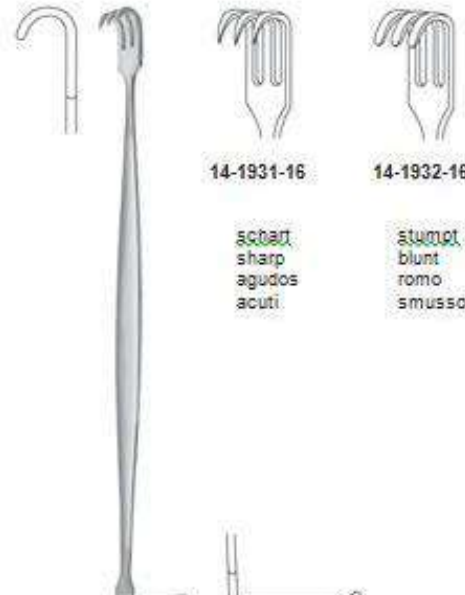

SENN-MILLER
16,0 cm, 6 1/2"

14-1931-16

14-1932-16

scharf
sharp
agudos
acuti

stumpf
blunt
romo
smusso



Wundhaken
Retractors
Separadores
Divaricatori



DESMARRES
13,0 cm, 5"



DESMARRES
16,0 cm, 6 1/4"



Wundhaken
Retractors
Separadores
Divaricatori



CUSHING
20.0 cm, 8"



8 mm
14-1935-08



10 mm
14-1935-10



12 mm
14-1935-12



14 mm
14-1935-14



16 mm
14-1935-16



18 mm
14-1935-18



CUSHING
24.0 cm, 9 1/4"



8 mm
14-1936-08



10 mm
14-1936-10



12 mm
14-1936-12



14 mm
14-1936-14



16 mm
14-1936-16



18 mm
14-1936-18

Wundhaken
Retractors
Separadores
Divaricatori



GIL-VERNET
24,0 cm, 9 1/2"



GIL-VERNET
24,0 cm, 9 1/2"



Wundhaken
Retractors
Separadores
Divaricatori



Fig. 124 x 20 mm
Fig. 229 x 26 mm
Fig. 333 x 29 mm
Fig. 429 x 24 mm

Satz, Fig. 1-3
Set, fig. 1-3
Juego, fig. 1-3
Serie, fig. 1-3

Fig. 130 x 28 mm
Fig. 236 x 36 mm
Fig. 338 x 43 mm
Fig. 445 x 28 mm

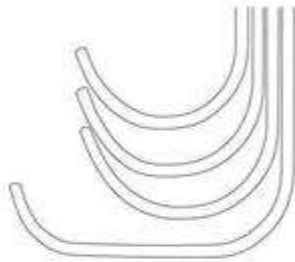

Fig. 1-3	17,0 cm, 6 3/4"	14-1940-00
Fig. 1	14,0 cm, 5 1/2"	14-1940-01
Fig. 2	15,0 cm, 6"	14-1940-02
Fig. 3	17,0 cm, 6 3/4"	14-1940-03
Fig. 4	18,0 cm, 7"	14-1940-04

ROUX
14-1939-12



Fig. 230 x 10 mm
Fig. 126 x 10 mm

Fig. 130 x 13 mm
Fig. 234 x 13 mm

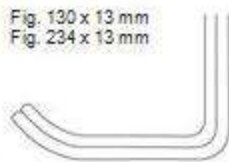

FARABEUF
12,0 cm, 4 3/4"
14-1941-12



Fig. 223 x 16 mm
Fig. 127 x 16 mm

Fig. 126 x 16 mm
Fig. 230 x 16 mm

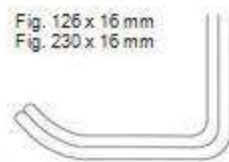

FARABEUF
15,0 cm, 5 3/4"
14-1941-15

Wundhaken
Retractors
Separadores
Divaricatori



MINI-ROUX
14,0 cm, 5 1/2"
14-1942-06



BABY-ROUX
13,0 cm, 5"
14-1943-13



PARKER
13,5 cm, 5 1/4"
14-1944-00

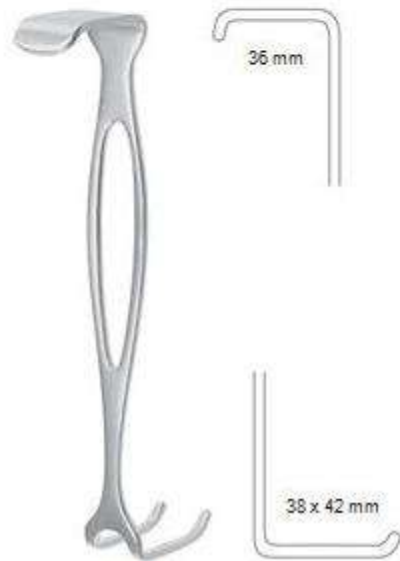

CZERNY
17,5 cm, 7"
14-1945-00



MATHIEU
20,0 cm, 8"
14-1946-00

Wundhaken
Retractors
Separadores
Divaricatori



GOELET
19,0 cm, 7 1/2"
14-1947-19



PARKER-LANGENBECK
21,0 cm, 8 1/4"
14-1948-00



CANNYRYAL

16mm	19,0 cm, 7 1/2"	14-1949-16
20mm	19,0 cm, 7 1/2"	14-1949-20
25 mm	20,0 cm, 8"	14-1949-25



Wundhaken
Retractors
Separadores
Divaricatori



VOLKMANN
21,5 cm. 8 1/2"



14-1950-01

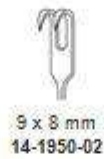

9 x 8 mm
14-1950-02



9 x 13 mm
14-1950-03



9 x 19 mm
14-1950-04



9 x 29 mm
14-1950-06



9 x 40 mm
14-1950-08

scharf
sharp
agudos
acuti



VOLKMANN
21,5 cm. 8 1/2"



14-1951-01



9 x 8 mm
14-1951-02



9 x 13 mm
14-1951-03



9 x 19 mm
14-1951-04



9 x 29 mm
14-1951-06

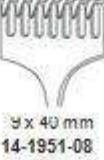

9 x 40 mm
14-1951-08

halbscharf
semi-sharp
semi-agudos
semi-acut

Wundhaken
Retractors
Separadores
Divaricatori



VOLKMANN
21,8 cm, 8 1/2"

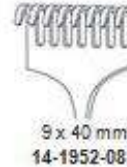

stumpf
blunt
romo
smusso



KOCHER
22,0 cm, 8 1/2"



scharf
sharp
agudos
acuti



Wundhaken
Retractors
Separadores
Divaricatori



KOCHER
22,0 cm, 8 1/2"



KOCHER
22,0 cm, 8 1/2"

14-1954-01

9 x 8 mm
14-1954-02

15 x 15 mm
14-1954-03

15 x 20 mm
14-1954-04

15 x 30 mm
14-1954-06

15 x 40 mm
14-1954-08

halbscharf
semi-sharp
semi-agudos
semi-acuti

14-1955-01

9 x 8 mm
14-1955-02

15 x 15 mm
14-1955-03

15 x 20 mm
14-1955-04

15 x 30 mm
14-1955-06

15 x 40 mm
14-1955-08

stumpf
blunt
romo
smusso

Wundhaken
Retractors
Separadores
Divaricatori



KOERTE
24,0 cm, 9 1/2"

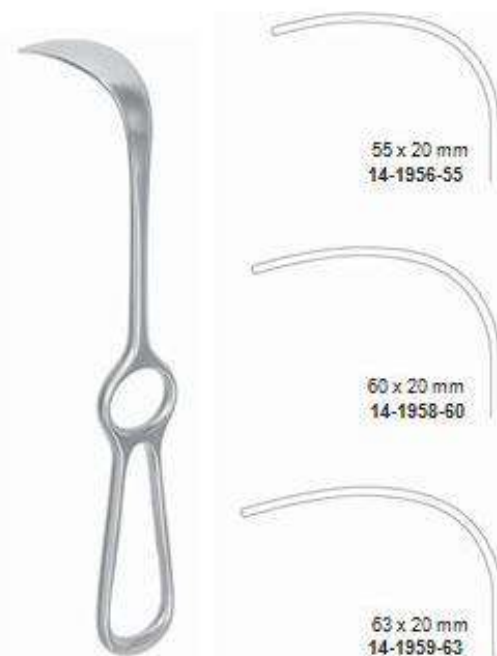

LANGENBECK
21,0 cm, 8 1/4"



ISRAEL
25,0 cm, 9 1/2"

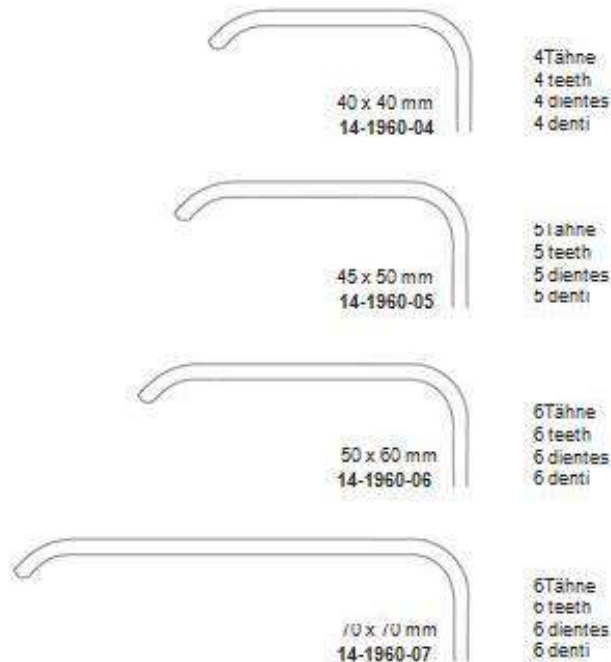

Wundhaken
Retractors
Separadores
Divaricatori



LANGENBECK
22,0 cm, 8 1/2"



LANGENBECK
22,0 cm, 8 1/2"

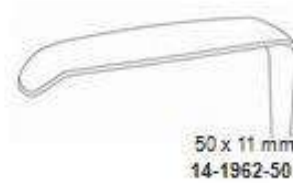

Wundhaken
Retractors
Separadores
Divaricatori



KOCHER-LANGENBECK
21,5 cm, 8 1/2"



22 x 6 mm
14-1963-22



25 x 6 mm
14-1963-25



25 x 8 mm
14-1963-26



35 x 8 mm
14-1963-35



35 x 11 mm
14-1963-36



35 x 15 mm
14-1963-37



40 x 11 mm
14-1963-40



70 x 15 mm
14-1963-70



80 x 12 mm
14-1963-80



80 x 15 mm
14-1963-85



22 x 6 mm
14-1963-22



Wundhaken
Retractors
Separadores
Divaricatori



KOCHER
23,0 cm, 9"

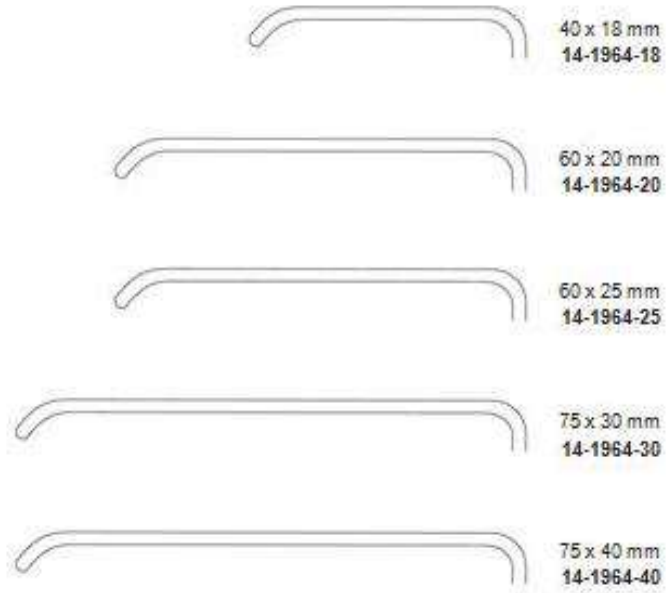

SAUERBRUCH
22,5 cm, 8 7/8"





Wundhaken
Retractors
Separadores
Divaricatori



MIDDELDORPF



21,5 cm, 8 1/2"
14 x 17 mm
14-1966-01



22,0 cm, 8 1/2"
20 x 22 mm
14-1966-02



23,5 cm, 9 1/4"
26 x 30 mm
14-1966-03



MIDDELDORPF



21,5 cm, 8 1/2"
14 x 17 mm
14-1967-01



22,0 cm, 8 1/2"
20 x 22 mm
14-1967-02



23,5 cm, 9 1/4"
26 x 30 mm
14-1967-03



RICHARDSON(KELLY)
24,0 cm, 9 1/2"



14-1968-01



9 x 8 mm
14-1968-02



15 x 15 mm
14-1968-03



15 x 20 mm
14-1968-04



15 x 30 mm
14-1968-06



15 x 40 mm
14-1968-08

Wundhaken
Retractors
Separadores
Divaricatori



Fig. 1+228,0cm,11"	14-1969-00
Fig. 126,0cm,10 1/2"	14-1969-01
Fig. 2 28,0 cm, 11"	14-1969-02

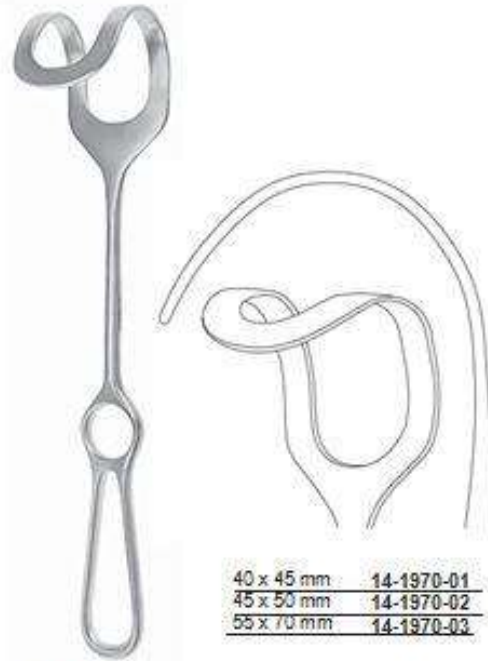

40 x 45 mm	14-1970-01
45 x 50 mm	14-1970-02
55 x 70 mm	14-1970-03

IDDELDORPF

RICHARDSON-EASTMAN
25,5 cm, 10"



45 x 40 mm	14-1971-40
45 x 50 mm	14-1971-50
45 x 60 mm	14-1971-60
55 x 75 mm	14-1971-75
65 x 85 mm	14-1971-85

FRITSCH
24,0 cm, 9 1/2"



DOYEN
25,0 cm, 10"
14-1972-8



DOYEN-STILLE
22,0 cm, 8⁵/₁₆"

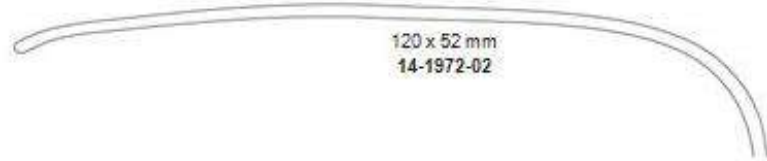

120 x 52 mm
14-1972-02

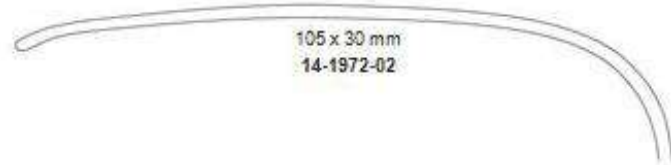

105 x 30 mm
14-1972-02



90 x 28 mm
14-1972-03



KOCHER
25,0 cm, 10"

70 x 25 mm	14-1973-70
80 x 42 mm	14-1973-81
80 x 50 mm	14-1973-82
80 x 60 mm	14-1973-83



LAHEY
19,0 cm, 7¹/₂"
14-1974-19

28 x 6 mm



Wundhaken
Retractors
Separadores
Divaricatori



LITTLE
20,0 cm, 8"
14-1976-20



115 x 22 mm	14-1975-01
115 x 27 mm	14-1975-02

SIMON
28,0 cm, 11"

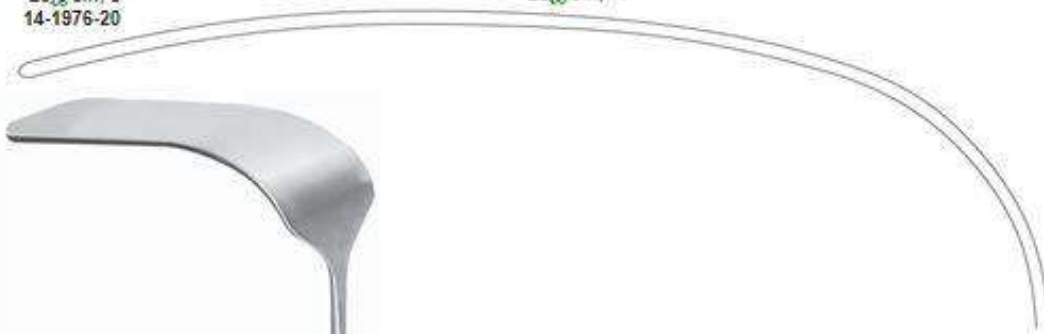

160x38mm	14-1977-61
160x57mm	14-1977-62
190x38mm	14-1977-91
190x57 mm	14-1977-92

KELLY
27,0 cm, 10 1/2"

Wundhaken
Retractors
Separadores
Divaricatori



85x35mm	14-1978-01
120x50mm	14-1978-02
155 x 50 mm	14-1978-03

MIKULICZ
26,0 cm, 10 1/4"



90 x 50 mm

MIKULICZ
26,0 cm, 10 1/4"
14-1980-90



70 x 38 mm	14-1979-38
70 x 50 mm	14-1979-51

MORRIS
24,5 cm, 9 3/4"

Wundhaken
Retractors
Separadores
Divaricatori



127 x 40 mm 14-1982-40
127 x 62 mm 14-1982-62

HARRINGTON
32,0 cm, 12¹/₂"



82x22mm 14-1981-01
108x43mm 14-1981-02
115x 65 mm 14-1981-03

CORYKKOS
24,0 cm, 9¹/₂"



ZENKER

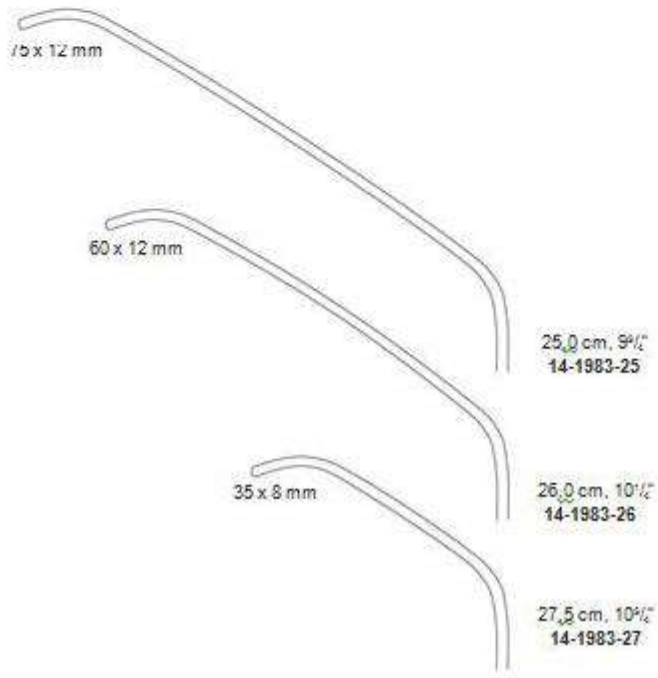

75 x 12 mm

60 x 12 mm

35 x 8 mm

25,0 cm, 9¹/₂"
14-1983-25

26,0 cm, 10¹/₂"
14-1983-26

27,5 cm, 10³/₄"
14-1983-27

Wundhaken
Retractors
Separadores
Divaricatori



MEYERDING
22,5 cm, 8 7/8"

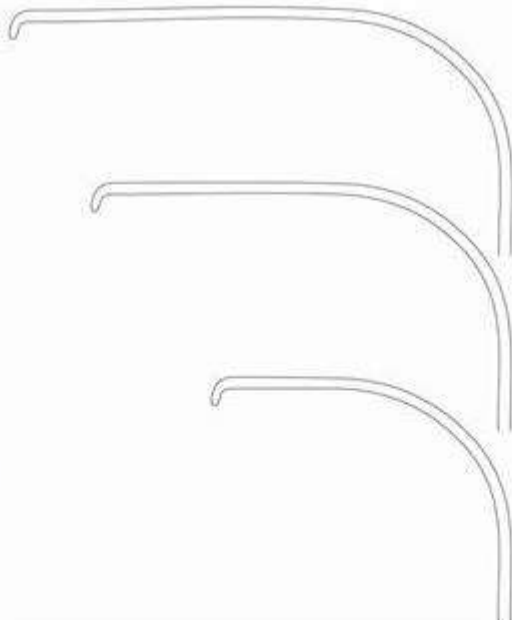

90 x 50 mm
14-1984-50

75 x 25 mm
14-1984-25

50 x 16 mm
14-1984-16



BRUNNER
25,0 cm, 10"

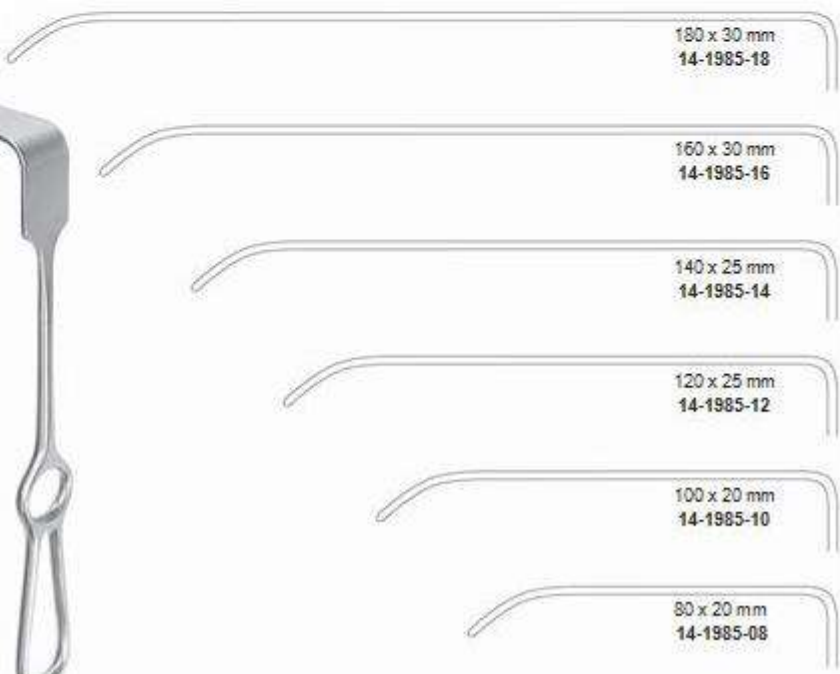

180 x 30 mm
14-1985-18

160 x 30 mm
14-1985-16

140 x 25 mm
14-1985-14

120 x 25 mm
14-1985-12

100 x 20 mm
14-1985-10

80 x 20 mm
14-1985-08

Wundhaken
Retractors
Separadores
Divaricatori



BRUNNER
25,0 cm, 10"



180 x 30 mm
14-1986-18

160 x 30 mm
14-1986-16

140 x 25 mm
14-1986-14

120 x 25 mm
14-1986-12

100 x 20 mm
14-1986-10

80 x 20 mm
14-1986-08



19 mm

DEAVER
18,0 cm, 7"
14-1987-18



22 mm

DEAVER
21,5 cm, 8 1/2"
14-1987-22



25 mm

DEAVER
23,0 cm, 9"
14-1987-23

Wundhaken
Retractors
Separadores
Divaricatori



25 mm

DEAVER
30,0 cm, 11³/₄"
14-1987-30



25 mm

DEAVER
33,0 cm, 13"
14-1987-33



25 mm

DEAVER
36,0 cm, 14¹/₄"
14-1987-36



38 mm

DEAVER
30,0 cm, 11³/₄"
14-1987-38



50 mm

DEAVER
30,0 cm, 11³/₄"
14-1987-50

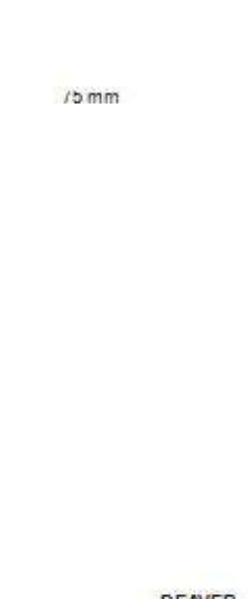

75 mm

DEAVER
30,0 cm, 11³/₄"
14-1987-75



Wundhaken
Retractors
Separadores
Divaricatori



25mm	14-1988-25
35mm	14-1988-35
50mm	14-1988-50
75mm	14-1988-75

DEAVERGRIP
30,0 cm, 11 1/2"



ALLISON

40 mm	30,0 cm, 11 1/2"	14-1989-30
54 mm	32,0 cm, 12 1/2"	14-1989-32



DAVID SON

75 x 50 mm	16,0 cm, 6 1/2"	14-1990-50
75 x 90 mm	16,0 cm, 6 1/2"	14-1990-90



STMARKS

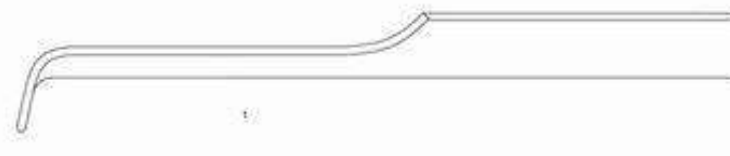

29,0 cm, 11 1/2"
130 x 60 mm
14-1991-01

33,0 cm, 13"
180 x 60 mm
14-1991-02

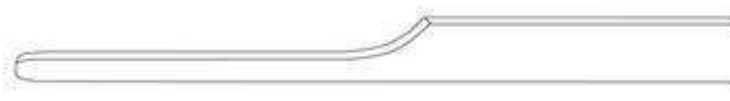

29,0 cm, 11 1/2"
130 x 60 mm
14-1992-01

33,0 cm, 13"
180 x 60 mm
14-1992-02

Wundspreizer
 Self-Retaining Retractors
 Separadores con retenida automatic
 Divaricatori autostatici



5,0 cm, 2" 14-1993-05

5,0 cm, 2" 14-1994-05

7,0 cm, 2 3/4" 14-1993-07

7,0 cm, 2 3/4" 14-1994-07

scharf sharp agudos acuti

stumpf blunt romo smusso

FINSEN



JANSEN
10,0 cm, 4"

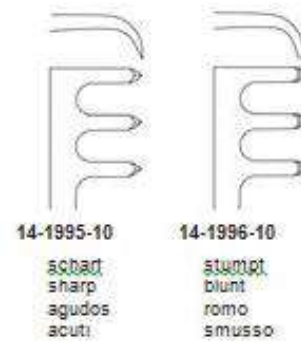

14-1995-10

scharf sharp agudos acuti

14-1996-10

stumpf blunt romo smusso

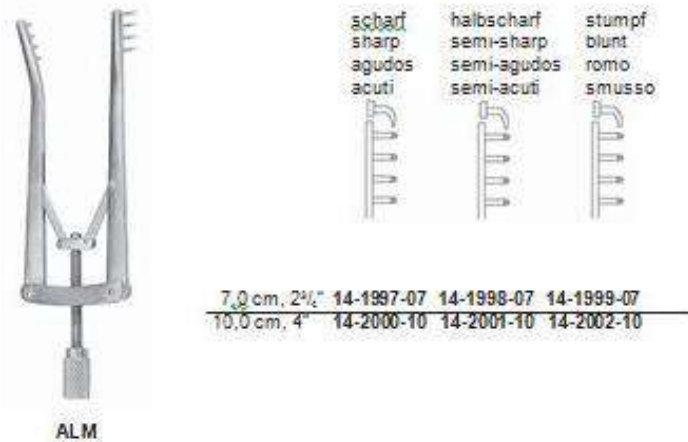

scharf sharp agudos acuti

halbscharf semi-sharp semi-agudos semi-acuti

stumpf blunt romo smusso

7,0 cm, 2 3/4" 14-1997-07 14-1998-07 14-1999-07

10,0 cm, 4" 14-2000-10 14-2001-10 14-2002-10

ALM



ALLPORT
9,5 cm, 3 3/4" 14-2003-09

Wundspreizer
Self-Retaining Retractors
Separadores con retenida automática
Divaricatori autostatici



SALP-CONTOUR
14,0 cm, 5 1/2"

14-2004-14
scharf
sharp
agudos
acuti

14-2005-14
stumpf
blunt
romo
smusso



AD SON-BABY
16,0 cm, 6 1/4"

14-2006-16
scharf
sharp
agudos
acuti

14-2007-16
stumpf
blunt
romo
smusso



ANDER SON-ADSON
20,0 cm, 8"

14-2008-14
scharf
sharp
agudos
acuti

14-2009-14
stumpf
blunt
romo
smusso



AD SON
26,5 cm, 10 1/2"

14-2010-16
scharf
sharp
agudos
acuti

14-2011-16
stumpf
blunt
romo
smusso

Wundspreizer
Self-Retaining Retractors
Separadores con retenida automática
Divaricatori autostatici

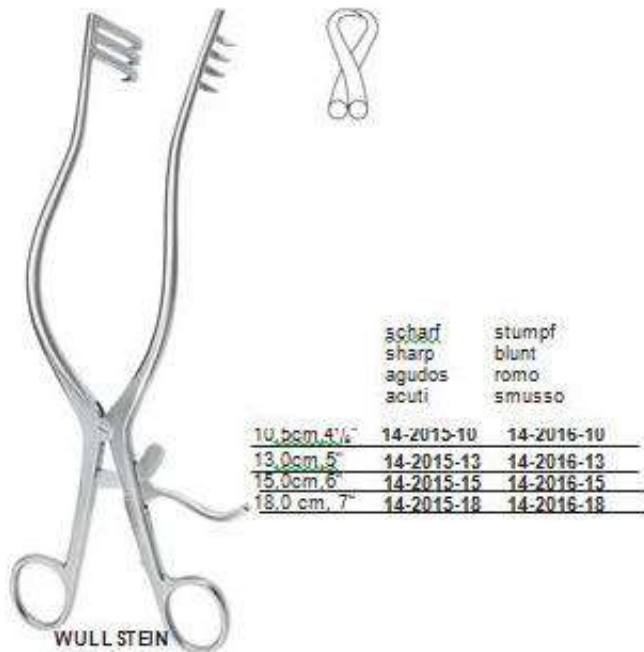



Wundspreizer
Self-Retaining Retractors
Separadores con retenida automática
Divaricatori auto statici



WEITLANER-LOKTITE
10,5 cm, 4 1/4"



14-2018-10
scharf
sharp
agudos
acuti



14-2019-10
stumpf
blunt
romo
smusso



WEITLANER
13,0 cm, 5"



14-2020-13
scharf
sharp
agudos
acuti



14-2021-13
stumpf
blunt
romo
smusso



WEITLANER
16,5 cm, 6 1/2"



14-2022-16
scharf
sharp
agudos
acuti



14-2023-16
stumpf
blunt
romo
smusso



WEITLANER
20,0 cm, 8"



14-2024-20
scharf
sharp
agudos
acuti



14-2025-20
stumpf
blunt
romo
smusso



Wundspreizer
Self-Retaining Retractors
Separadores con retenida automática
Divaricatori auto statici



WEITLANER
24,0 cm, 9 1/2"



14-2026-20

scharf
sharp
agudos
acuti



14-2027-20

stumpf
blunt
romo
smusso



PLESTER
13,0 cm, 5"



14-2028-13

scharf
sharp
agudos
acuti



14-2029-13

stumpf
blunt
romo
smusso



MILLIGAN
13,0 cm, 5"
14-2030-13



PLESTER
11,0 cm, 4 1/2"
14-2031-11



PLESTER
11,0 cm, 4 1/2"
14-2032-11



Wundspreizer
Self-Retaining Retractors
Separadores con retenida automatic
Divaricatori auto statici



WEITLANER-BABY
13,0 cm, 5"
14-2035-13



**ADSON
(CONE)**

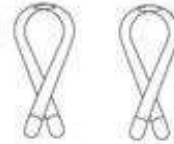

20,0 cm, 8"	14-2033-20	14-2034-20
26,0 cm, 10 1/4"	14-2033-26	14-2034-26

scharf	stumpf
sharp	blunt
agudos	romo
acuti	smusso



GELPI
13,5 cm, 5 1/4"
14-2036-14



GELPI
19,0 cm, 7 1/2"
14-2037-19



GELPI-LOKTITE
19,0 cm, 7 1/2"
14-2038-19

Wundspreizer
 Self-Retaining Retractors
 Separadores con retenida automática
 Divaricatori auto statici



BECKMANN-ADSON
 31,0 cm, 12 1/4"

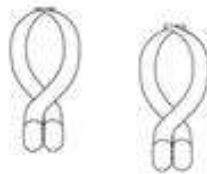

25x25mm	14-2039-01	14-2040-01
25x31mm	14-2039-02	14-2040-02
25x40mm	14-2039-03	14-2040-03
25 x 45 mm	14-2039-04	14-2040-04

scharf	stumpf
sharp	blunt
agudos	romo
acuti	smusso



BECKMANN
 31,0 cm, 12 1/4"



14-2041-31
 scharf
 sharp
 agudos
 acuti

Wundspreizer
Self-Retaining Retractors
Separadores con retenida automatic
Divaricatori autostatici

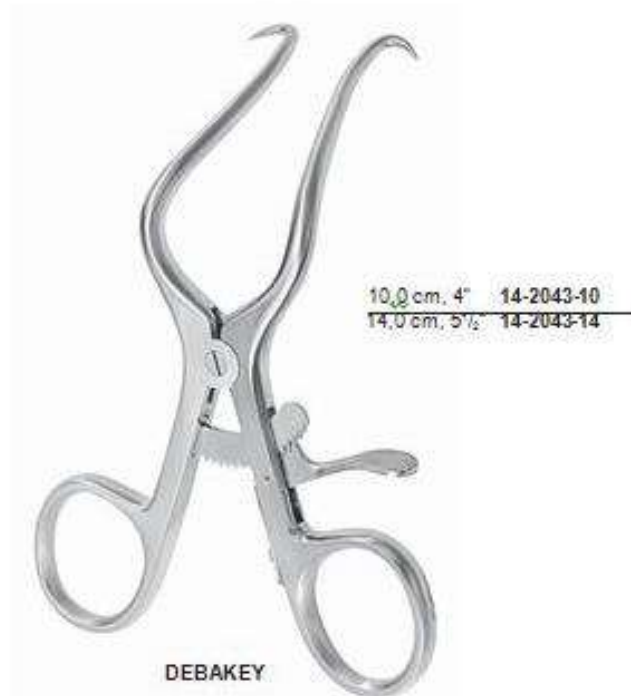



Wundspreizer
Self-Retaining Retractors
Separadores con retenida automática
Divaricatori auto statici



NORFOLK AND NORWICH
22,0 cm, 8 1/2"
14-2044-22



stumpf
blunt
romo
smusso



JACK SONBURROWS
17,5 cm, 7"
14-2045-17



stumpf
blunt
romo
smusso



RICHTER
17,0 cm, 6 1/2"
14-2046-17



JOLL (FRIEDMAN)
15,5 cm, 6"
14-2047-15

Wundspreizer
Self-Retaining Retractors
Separadores con retenida automatic
Divaricatori autostatici

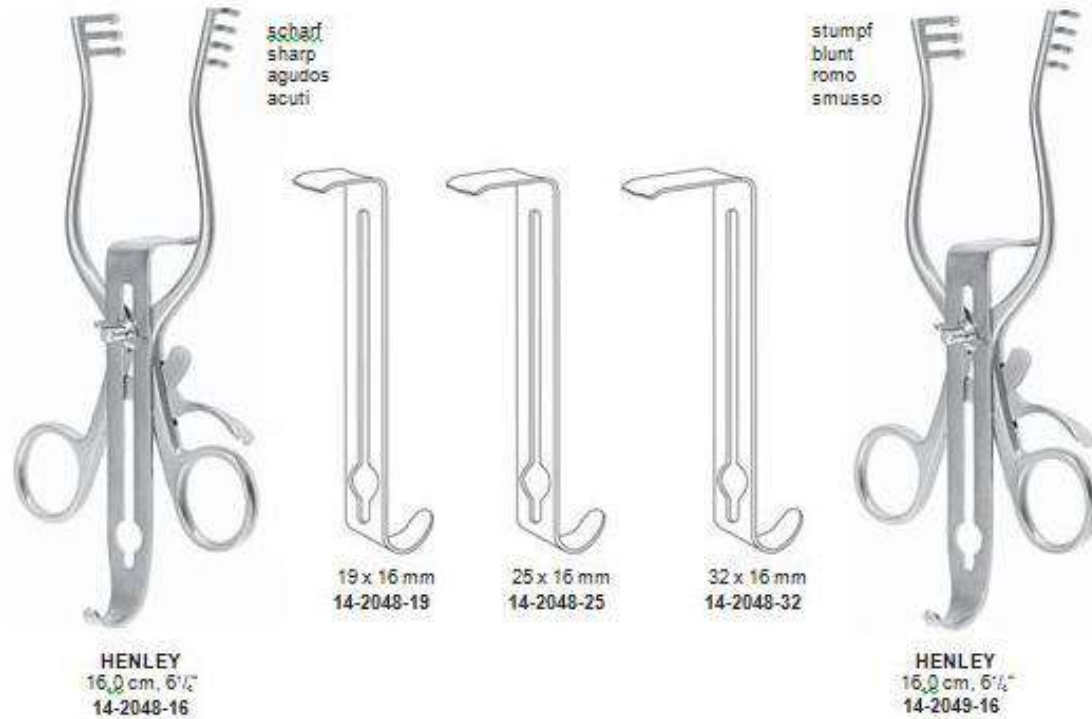

HENLEY
16,0 cm, 6 1/4"
14-2048-16

HENLEY
16,0 cm, 6 1/4"
14-2049-16

HENLEY
14-2050-00

komplett, bestehend aus:

- 1 Sperrer mit Seitenventilen, scharf (14-300-16)
- 1 Mittelvalve 19 x 16 mm (14-300-19)
- 1 Mittelvalve 25 x 16 mm (14-300-25)
- 1 Mittelvalve 32 x 16 mm (14-300-32)

complete, consisting of:

- 1 Spreader with lateral valves, sharp (14-300-16)
- 1 Central valve 19 x 16 mm (14-300-19)
- 1 Central valve 25 x 16 mm (14-300-25)
- 1 Central valve 32 x 16 mm (14-300-32)

completo, compuesto de:

- 1 Separador con valvas laterales, agudas (14-300-16)
- 1 Valva central 19 x 16 mm (14-300-19)
- 1 Valva central 25 x 16 mm (14-300-25)
- 1 Valva central 32 x 16 mm (14-300-32)

completo, composto da:

- 1 Divaricatore con valve laterali, acuto (14-300-16)
- 1 Valva centrale 19 x 16 mm (14-300-19)
- 1 Valva centrale 25 x 16 mm (14-300-25)
- 1 Valva centrale 32 x 16 mm (14-300-32)

HENLEY
14-2051-00

komplett, bestehend aus:

- 1 Sperrer mit Seitenventilen, stumpf (14-301-16)
- 1 Mittelvalve 19 x 16 mm (14-300-19)
- 1 Mittelvalve 25 x 16 mm (14-300-25)
- 1 Mittelvalve 32 x 16 mm (14-300-32)

complete, consisting of:

- 1 Spreader with lateral valves, blunt (14-301-16)
- 1 Central valve 19 x 16 mm (14-300-19)
- 1 Central valve 25 x 16 mm (14-300-25)
- 1 Central valve 32 x 16 mm (14-300-32)

completo, compuesto de:

- 1 Separador con valvas laterales, romas (14-301-16)
- 1 Valva central 19 x 16 mm (14-300-19)
- 1 Valva central 25 x 16 mm (14-300-25)
- 1 Valva central 32 x 16 mm (14-300-32)

completo, composto da:

- 1 Divaricatore con valve laterali, smusso (14-301-16)
- 1 Valva centrale 19 x 16 mm (14-300-19)
- 1 Valva centrale 25 x 16 mm (14-300-25)
- 1 Valva centrale 32 x 16 mm (14-300-32)

Wundspreizer, Bauchdeckenhalter
 Self-Retaining Retractors, Abdominal Retractors
 Separadores con retenida automática,
 Separadores abdominales,
 Divaricatori autostatici, Divaricatori addominali



MAYO-ADAMS
 17,0 cm, 6 1/2"
 14-2054-17



COLLIN-BABY
 18,0 cm, 7"
 14-2055-18

30 x 44 mm
 14-2052-30



23 x 44 mm
 14-2053-23

Wechselvalven
 Exchangeable blades
 Valvas intergambiables
 Valve intercambiabili



RICARD
 28,0 cm, 11"
 14-2056-28



RICARD
 30,0 cm, 12"
 14-2057-30

Wundspreizer, Bauchdeckenhalter
 Self-Retaining Retractors, Abdominal Retractors
 Separadoresooretenidaautomática,
 Separadoresabdominales
 Divaricatoriautostatici,Divaricatoriaddominali



COLLIN
 23,5 cm, 9 1/4"
 14-2058-24



COLLIN
 23,5 cm, 9 1/4"
 14-2059-24



COLLIN
 23,5 cm, 9 1/4"
 14-2060-24



ROBIN-MASSE
 14-2061-27



Wundspreizer, Bauchdeckenhalter
 Self-Retaining Retractors, Abdominal Retractors
 Separadores con retenida automática, Separadores abdominales
 Divaricatori auto statici, Divaricatori addominali



38x62mm	14-2062-01
40x80mm	14-2062-02
60 x 80 mm	14-2062-03



50x58mm	14-2063-10
60x80mm	14-2063-13
72 x 85 mm	14-2063-14



14-2064-23
60 x 80 mm



14-2067-33
60 x 80 mm



56x50mm	14-2065-01
80x60mm	14-2065-02
85 x 72 mm	14-2065-03



62x38mm	14-2066-10
80x38mm	14-2066-11
100x38mm	14-2066-12
80 x 38 mm	14-2066-13



COLLIN

55 x 55 mm	14-2068-01
55 x 65 mm	14-2068-02
55 x 75 mm	14-2068-03



ROBIN-MASSÉ

40x64mm	14-2069-01
55x65mm	14-2069-02
55 x 75 mm	14-2069-03



RICARD

65 x 50 mm	14-2070-01
70 x 55 mm	14-2070-02
90 x 80 mm	14-2070-03

Bauchdeckenhalter
Abdominal Retractors
Separadores abdominales
Divaricatori addominali



Bauchdeckenhalter
 Abdominal Retractors
 Separadores abdominales
 Divaricatori addominali



BALFOUR
14-2075-18



BALFOUR
14-2076-20



BALFOUR
14-2077-25



BALFOURUS-TYPE
14-2078-25

Bauchdeckenhalter
Abdominal Retractors
Separadores abdominales
Divaricatori addominali

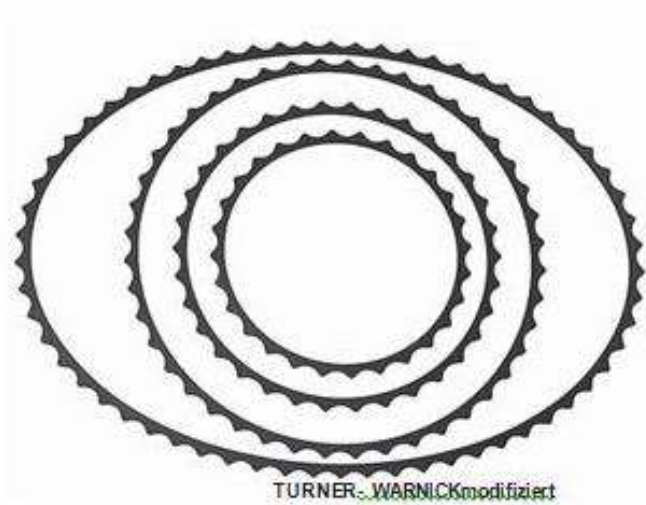
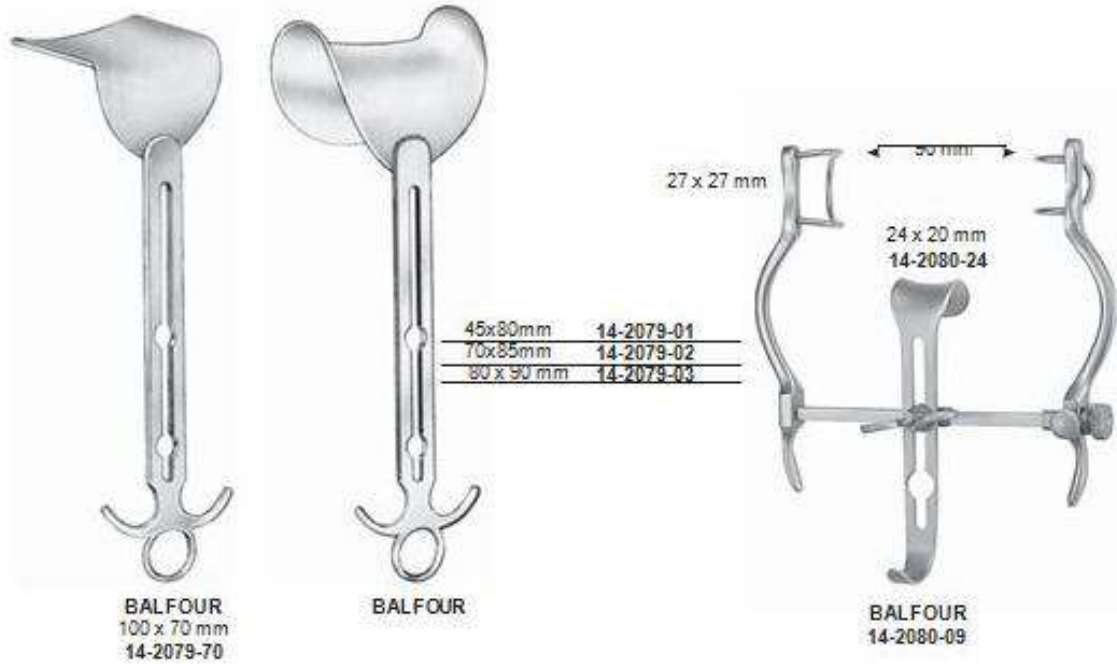

Ø180mm, 7"	14-2081-18
Ø230mm, 9"	14-2081-23
Ø305mm, 12"	14-2081-30
455 x 330 mm	14-2081-45



Bauchdeckenhalter
Abdominal Retractors
Separadores abdominales
Divaricatori addominali

geschwärzt, black finish, negra, nera



14-2082-01
13 mm



14-2082-02
51 x 38 mm



14-2082-03
70 x 60 mm



14-2082-04
89 x 60 mm



14-2082-05
114 x 60 mm

TURNER-WARNICKmodifiziert

geschwärzt, black finish, negra, nera



14-2083-06
19 x 76 mm



14-2083-07
38 x 102 mm



14-2083-08
57 x 89 mm



14-2083-09
57 x 114 mm

Bauchdeckenhalter
Abdominal Retractors
Separadores abdominales
Divaricatori addominali



14-2084-01
255x180mm
Rahmen allein
frame only
cuadro suelto
solo telaio

DENNIS BROWN2
55x180mm
14-2084-00
komplett complete
completocompleto

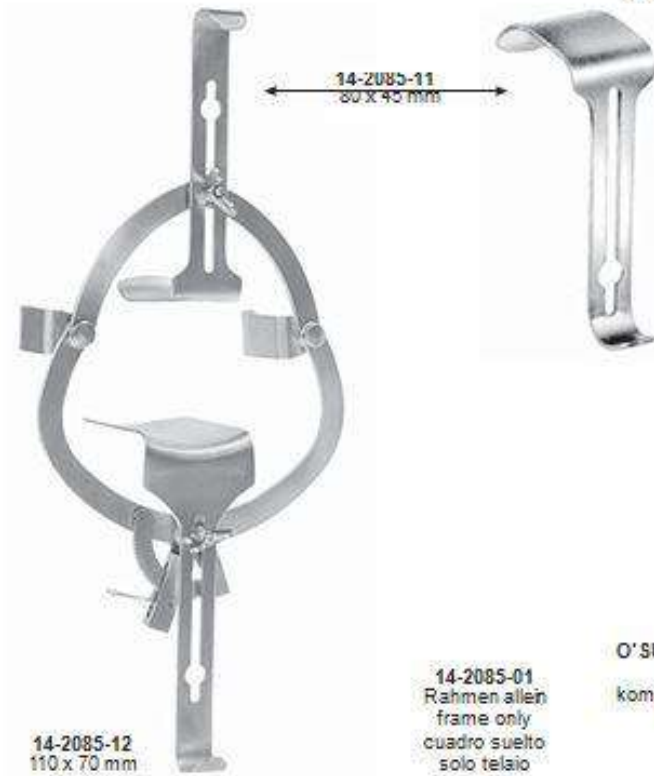



Bauchdeckenhalter
Abdominal Retractors
Separadores abdominales
Divaricatori addominali

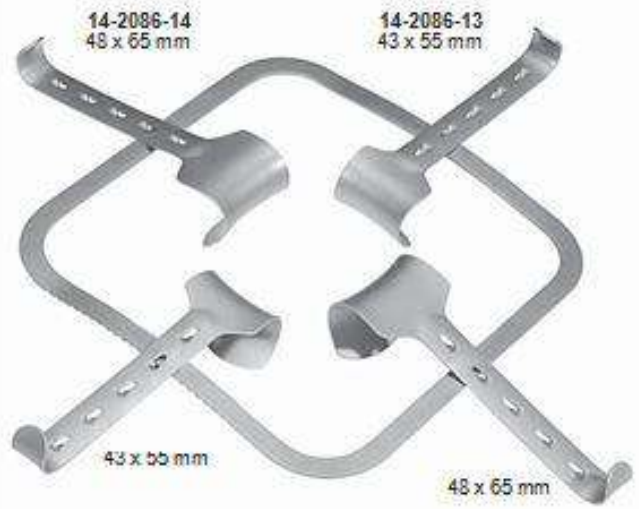

14-2086-01 250 x 250 mm
14-2087-01 300 x 320 mm
14-2088-01 300 x 380 mm
Rahmen alleinframe
onlycuadro suelto solo telaio

KIR SCHNER
14-2089-00
komplett
complete
completo
completo
1 x 14-880-01
2 x 14-880-13
2 x 14-880-14



14-2090-01
255 x 255 mm
zusammenlegbarer Rahmen, allen
folding frame, onlycuadro piegabile,
sueiltelaio pieghevole, solo

KIR SCHNER
14-2090-00
komplett
complete
completo
completo
1 x 14-882-01
2 x 14-880-13
2 x 14-880-14



43x55mm	14-2091-13
48x65mm	14-2091-14
80x90mm	14-2091-15
90x65mm	14-2091-16
98x95mm	14-2091-17

KIR SCHNER



Bauchdeckenhalter
Abdominal Retractors
Separadores abdominales
Divaricatori addominali



KIR SCHNER
60 x 82 mm
14-2092-11



KIR SCHNER-BALFOUR
83 x 82 mm
14-2092-12



KIR SCHNER
98 x 51 mm 14-2092-20
105 x 38 mm 14-2092-21



14-2093-14
48 x 65 mm

14-2094-01
300 x 240 mm
Rahmen allein
frame only
cuadro suelto
solo telaio

14-2095-15
80 x 90 mm

KIR SCHNER,oval
14-2096-00
komplett, complete, completo, completo
1 x 14-094-013 x 14-093-141 x 14-095-151
1b1 x 14-097-201 x 14-097-21



KIR SCHNER
98 x 51 mm 14-2097-20
105 x 38 mm 14-2097-21



Bauchdeckenhalter
Abdominal Retractors
Separadores abdominales
Divaricatori addominali

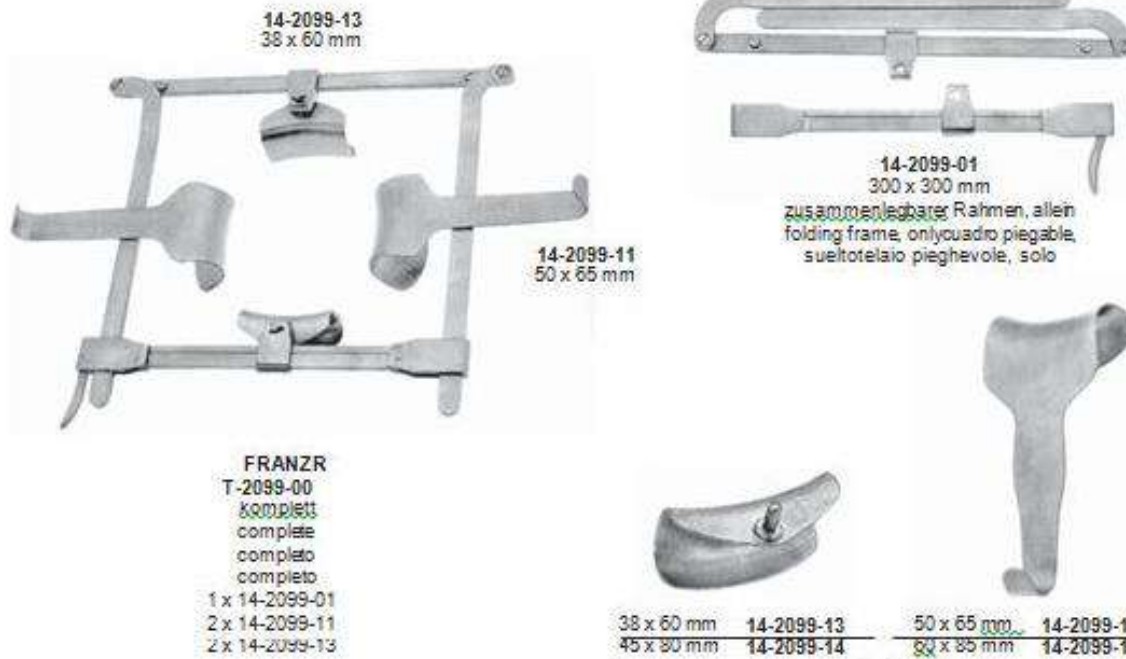
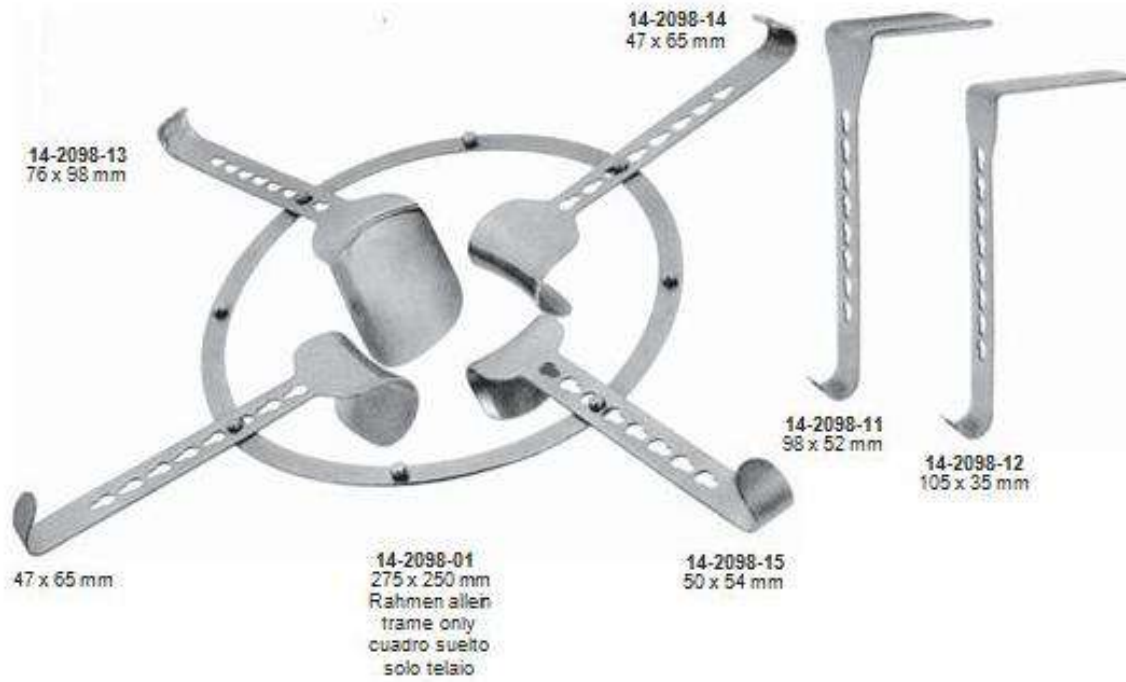

Bauchdeckenhalter
Abdominal Retractors
Separadores abdominales
Divaricatori addominali

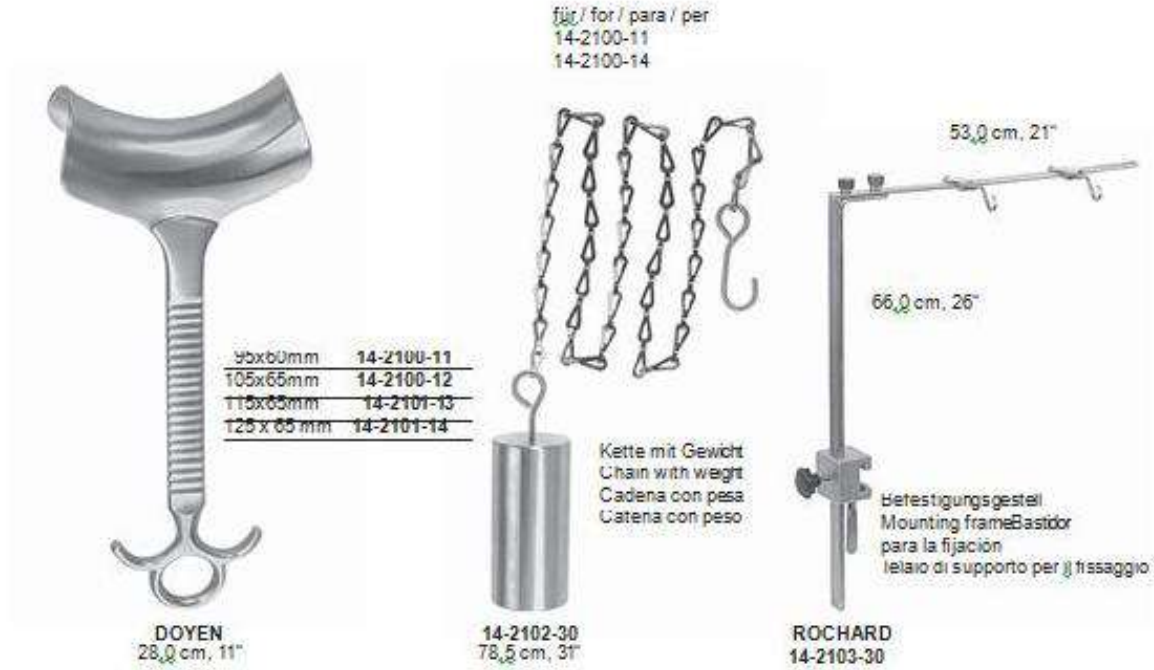



Bauchdeckenhalter
Abdominal Retractors
Separadores abdominals
Divaricatori addominali



biegssam
malleable
maleable
malleabile

200x 6mm	14-2105-06
200x12mm	14-2105-12
200x17 mm	14-2105-17
200x20mm	14-2105-20
200 x 25 mm	14-2105-25

RIBBON



biegssam
malleable
maleable
malleabile

330x13mm	14-2106-13
330x25mm	14-2106-25
330x32mm	14-2106-32
330x40mm	14-2106-40
330 x 50 mm	14-2106-50

RIBBON



biegssam
malleable
maleable
malleabile

280x25/30mm	14-2107-01
300x37/45mm	14-2107-02
300 x 40/50 mm	14-2107-03

RIBBON
200 x 25/17 mm
14-2108-20



biegssam
malleable
maleable
malleabile

TUFFIER



REVERDIN
280 x 45/60 mm
14-2109-28

Rippensperer
Rib Spreaders
Separadores costales
Divaricatori costali



FINOCCHIETTO-BABY

a	b18	c	
mm	20 mm	75 mm	14-2110-01

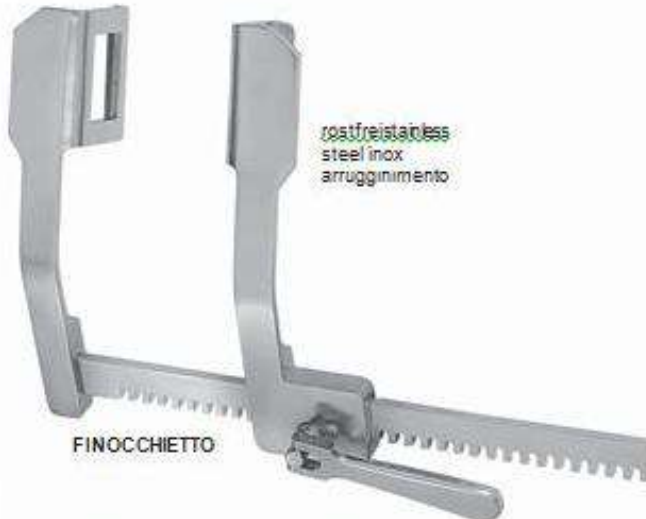

FINOCCHIETTO

a40	b	c	
mm 40	40 mm	165 mm	14-2110-02
mm 70	65 mm	200 mm	14-2110-03
mm	85 mm	250 mm	14-2110-04



TUFFIER

a	b50	c	
mm	45 mm	165 mm	14-2111-01



Sonden
Probes
Sondas
Sonde



Ø 1,0 mm Ø 2,0 mm

11,5cm, 4 1/2"	14-2112-11	14-2113-11
13,0cm, 5"	14-2112-13	14-2113-13
14,5cm, 5 1/2"	14-2112-14	14-2113-14
16,0cm, 6 1/2"	14-2112-16	14-2113-16
18,0cm, 7"	14-2112-18	14-2113-18
20,0cm, 8"	14-2112-20	14-2113-20

Ø 2,0 mm



11,5cm, 4 1/2"	14-2115-11
13,0cm, 5"	14-2115-13
14,5cm, 5 1/2"	14-2115-14
16,0cm, 6 1/2"	14-2115-16
18,0cm, 7"	14-2115-18
20,0cm, 8"	14-2115-20

Ø 1,0 mm



Silber
Silver
Plata
Argento

STACKE
10,5cm, 4 1/4"
14-2115-10

Myrtenblattsonden
Myrtle leaf probes
Sondas para mirto
Sonde a foglia di mirto



11,5cm, 4 1/2"	14-2116-11
13,0cm, 5"	14-2116-13
14,5cm, 5 1/2"	14-2116-14
16,0cm, 6 1/2"	14-2116-16
18,0cm, 7"	14-2116-18
20,0cm, 8"	14-2116-20



NELATON
16,0cm, 6 1/4"
14-2117-16



DOYEN
14,5cm, 5 1/2"
14-2118-14

Ø 3,5 mm



BRODIE
20,0cm, 8"
14-2119-20

Sonden
Probes
Sondas
Sonde

∅ 3,5 mm



11,0cm, 4 1/2"	14-2120-11
13,0cm, 5"	14-2120-13
14,5cm, 5 7/8"	14-2120-14
16,0cm, 6 1/2"	14-2120-16
18,0cm, 7"	14-2120-18
20,0 cm, 8"	14-2120-20

∅ 3,3 mm



13,0cm, 5"	14-2121-13
14,5cm, 5 7/8"	14-2121-14
16,0cm, 6 1/2"	14-2121-16
18,0 cm, 7"	14-2121-18



LOCKHART-MUMMERY
16,5 cm, 6 1/2"
14-2122-01



LOCKHART-MUMMERY
16,5 cm, 6 1/2"
14-2122-02



LOCKHART-MUMMERY
16,5 cm, 6 1/2"
14-2122-03



LOCKHART-MUMMERY
16,5 cm, 6 1/2"
14-2122-04



Watteträger
Cotton Applicators
Porta-algodones
Porta-cotone



FEIN
28,0 cm, 11"
14-2123-28



UKERMANN
16,0 cm, 6 1/2"
14-2124-16



JOB SON-HORNE
18,0 cm, 7"
14-2125-18



12,0cm, 4 1/2"	14-2126-12	Ø0,9mm
14,0cm, 5 1/2"	14-2126-14	Ø0,9mm
16,5cm, 6 1/2"	14-2126-16	Ø1,1mm
18,0 cm, 7"	14-2126-18	Ø1,2mm

**FARRELL
(LATHBURY)**



12,0cm, 4 1/2"	14-2127-12	Ø0,9mm
14,0cm, 5 1/2"	14-2127-14	Ø0,9mm
16,5cm, 6 1/2"	14-2127-16	Ø1,1mm
18,0 cm, 7"	14-2127-18	Ø1,2 mm

FARRELL

Krampfader-Besteck
 Varicose Vein Probe Set
 Juego para várices
 Astuccio per vanci



14-2128-01
 Metalltui
 Metal case
 Estuche de metal
 Scatola in metallo
 135 x 100 x 25 mm



Ø 3,0 mm
 14-2128-03



Ø 6,0 mm
 14-2128-06



Ø 9,0 mm
 14-2128-09



Ø 12,0 mm
 14-2128-12



14-2128-21
 Zugseil
 Cable/Cable
 Fune

14-2128-22
 Kunststoff-Sondenspitze
 Plastic probetip
 Extremidad de sonda de plastico
 Punta in materia plastica

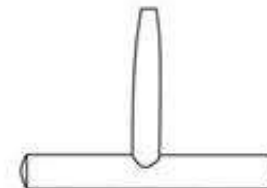

14-2128-20
 Handgriff
 Handle
 Mango
 Manico



Trokare
Trocars
Trócares
Trequartí



Ø 3,0 mm	14-2129-30
Ø 3,5 mm	14-2129-35
Ø 4,0 mm	14-2129-40
Ø 4,5 mm	14-2129-45
Ø 5,0 mm	14-2129-50
Ø 5,5 mm	14-2129-55
Ø 6,0 mm	14-2129-60

STANDARD
11,0 cm, 4 1/2"



Ø 3,0 mm	14-2130-30
Ø 3,5 mm	14-2130-35
Ø 4,0 mm	14-2130-40
Ø 4,5 mm	14-2130-45
Ø 5,0 mm	14-2130-50
Ø 5,5 mm	14-2130-55
Ø 6,0 mm	14-2130-60

STANDARD
12,0 cm, 4 1/2"



Ø 3,0 mm	14-2131-30
Ø 3,5 mm	14-2131-35
Ø 4,0 mm	14-2131-40
Ø 4,5 mm	14-2131-45
Ø 5,0 mm	14-2131-50
Ø 5,5 mm	14-2131-55
Ø 6,0 mm	14-2131-60

STANDARD
12,0 cm, 4 1/2"



Ø 3,0 mm	14-2132-07
Ø 5,7 mm	14-2132-09
Ø 12,0 mm	14-2132-12

HURWITZ



Ø 4,5 mm Ø 3,0 mm Ø 1,75 mm

UNIVERSAL
14-2132-03



Ø 6,0 mm Ø 4,5 mm

Ø 3,0 mm Ø 1,75 mm

UNIVERSAL
14-2132-04

Trokare
Trocars
Trócares
Trequarti



UNIVERSAL
14-2133-03



UNIVERSAL
14-2133-04

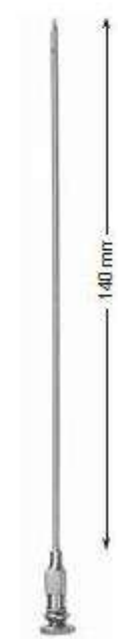

LANDAU
Ø 2,0 mm
14-2134-16



LANDAU
Ø 2,0 mm
14-2135-16



DAVID SON
Ø 6,0 mm
14-2136-18



BUELAU
Ø 8,0 mm
14-2137-24



Trokare
Trocares
Trócares
Trequarti



Ø 2,0 mm	14-2138-20
Ø 2,5 mm	14-2138-25
Ø 3,0 mm	14-2138-30



Ø 6,0 mm	14-2139-06
Ø 8,0 mm	14-2139-08

LERMOYEZ CAMPBELL
16,0 cm, 6 1/4"



Ø 1,5mm	14-2140-01
Ø 3,0mm	14-2140-02
Ø 10,5mm	14-2140-03
Ø 12,0mm	14-2140-04

NELSON
21,0 cm, 8 1/4"



Ø 4,0 mm	14-2141-01
Ø 4,6 mm	14-2141-02
Ø 5,5 mm	14-2141-03
Ø 6,5 mm	14-2141-04

OCHSNER
14,0 cm, 5 1/4"



Record Konus
Record cone

Ø 3,0 mm	14-2142-30
Ø 4,0 mm	14-2142-40
Ø 5,0 mm	14-2142-50

PIERCE
16,0 cm, 6 1/4"



COAKLEY
14,0 cm, 5 1/4"
14-2143-14



KRAUSE
 16,0 cm, 6 1/4"

LIGHTWITZ
 Kieferhöhlentrocars
 Antrum trocars
 Trocares para el seno maxilar
 Trequartiperpunturadelsenomascellare

LIGHTWITZ
 20,0 cm, 8"
 14-2145-00

Trocare, Saugrohre
 Trocars, Suction Tubes
 Trócares, Tubos para aspiración
 Trequarti, Tubi aspirazione

LIGHTWITZ
 11,0 cm, 4 1/4"
 14-2145-00



DOUGLAS
 Ø 3,0 mm
 14-2146-00



POOLER
 22,0 cm, 8 3/4"
 Ø 6,0 mm 14-2147-06
 Ø 10,0 mm 14-2147-10



POOLER
 22,0 cm, 8 3/4"
 Ø 6,0 mm 14-2148-06
 Ø 8,0 mm 14-2148-08



Saugrohre
Suction Tubes
Tubos para aspiración
Tubi aspirazione

auswechselbare Spitze
interchangeable tip
punta intercambiabile
tipo intercambiabile



Ø 3,5 mm
ST-2149-35

ST-2150-00
Olive allen
Olive only
Oliva suevo
Olivo solo

COUPLAND
17,0 cm, 6 1/2"
14-2149-17

YANKAUER
27,0 cm, 10 3/4"
14-2150-27

DEBAKEY
27,0 cm, 10 3/4"
14-2151-27

ANTHONY
26,0 cm, 10 1/4"
14-2151-26

ANDREWS-PYNCHON
24,0 cm, 9 1/2"
14-2151-24



COOLEY
35,0 cm, 13 3/4"
Ø 8,0 mm
14-2152-02



COOLEY
30,0 cm, 11 1/4"
Ø 7,0 mm
14-2153-03



COOLEY
31,0 cm, 11 3/4"
Ø 10,0 mm
14-2154-04



COOLEY
33,0 cm, 13"
Ø 8,0 mm
14-2155-01



Ø 2,0 mm

COGSWELL
23,0 cm, 9"
14-2156-23



Saugrohre
Suction Tubes
Tubos para aspiración
Tubi aspirazione



BYRD
20,0 cm, 8"

Ø 1,5 mm	14-2157-15
Ø 2,5 mm	14-2157-23
Ø 3,5 mm	14-2157-35



HEPPI/SCHIEDL
22,5 cm, 8 7/8"
14-2158-22

Ø 4,0 mm



ADSON
21,0 cm, 8 1/4"
14-2159-21



MAGILL
17,5 cm, 6 7/8"

Ø 1,0 mm	14-2160-01
Ø 2,0 mm	14-2160-02
Ø 3,0 mm	14-2160-03
Ø 4,0 mm	14-2160-04



FRAZIER
19,0 cm, 7 1/2"

Chart. 8	14-2161-06
Chart. 8	14-2161-08
Chart. 10	14-2161-10
Chart. 12	14-2161-12



FERGUSSON
18,0 cm, 7"

Chart. 8	14-2162-06
Chart. 8	14-2162-08
Chart. 10	14-2162-10
Chart. 12	14-2162-12



POPPEN
13,0 cm, 5"

Chart. 8	14-2163-06
Chart. 8	14-2163-08
Chart. 10	14-2163-10
Chart. 12	14-2163-12



Nierensteinzangen, Gallensteinzangen
 Kidney Stone Forceps, Gall Stone Forceps
 Pinzas para los cálculos renales, Pinzas para los cálculos biliares
 Pinze per calcoli renali, Pinze per calcoli biliari



RANDALL



23,0 cm, 9"
14-2164-01



22,0 cm, 8 1/2"
14-2164-02



22,0 cm, 8 1/2"
14-2164-03



22,0 cm, 8 1/2"
14-2164-04



19,0 cm, 7 1/2"
14-2164-05



19,0 cm, 7 1/2"
14-2164-06



DESJARDINS
23,0 cm, 9"



14-2165-01



14-2165-02



MIXTER
22,0 cm, 8 1/2"
14-2166-22



MAYOBLAKE
20,0 cm, 8"
14-2168-20



20,0 cm, 8"
14-2169-20

Gallen steinzangen
 Gall Stone Forceps
 Pinzas para los cálculos biliares
 Pinze per calcoli biliari



BLAKE
 20,0 cm, 8"
 14-2170-20



TURNER-WARWICK
 18,0 cm, 7"



SÖKELAND
 24,0 cm, 9 1/2"
 14-2174-24



CZERNY
 24,5 cm, 9 3/4"
 14-2175-24



Gallen steinlöffel
Gall Stone Scoops
Cucharillas para los cálculos biliares
Cucchiai per calcoli biliari



LUER-KORTE
24,0 cm, 9 1/2"

Fig. 000
2,8 mm
14-2176-01

Fig. 00
3,4 mm
14-2176-02

Fig. 2
6,7 mm
14-2176-05

Fig. 3
8,0 mm
14-2176-06

Fig. 0
4,3 mm
14-2176-03

Fig. 1
5,5 mm
14-2176-04

Fig. 4
11,0 mm
14-2176-07

Fig. 5
15,0 mm
14-2176-08



FERGUSSON
21,5 cm, 8 1/2"
14-2177-01



MAYO
27,0 cm, 10 3/8"
14-2178-01



MAYO
27,0 cm, 10 3/8"

14-2179-01



14-2179-02



MOYNIHAN
34,0 cm, 13 1/4"
14-2180-34



Gallengangsonden, Gallengang Dilatoren
 Gall Duct Probes, Common Bile Duct Dilators
 Sonas p. el conducto biliar,
 Dilatadores para el conducto biliar
 Dilatatori per condotti biliari, Dilatatori per coledoco



MAYO
 32,0 cm, 12 1/2"
 14-2181-32



OCHSNER
 35,0 cm, 13 3/4"
 14-2182-35



DESJARDINS
 28,0 cm, 11"

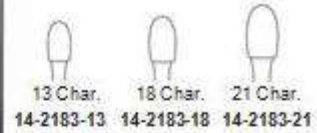

MOORE
 30,0 cm, 12"
 14-2185-30

Gallenblasenöffel
 Gall bladder scoope
 Cuccharilla para la vesícula biliar
 Cucchiaino per colecisti



DESJARDINS
 28,0 cm, 11"

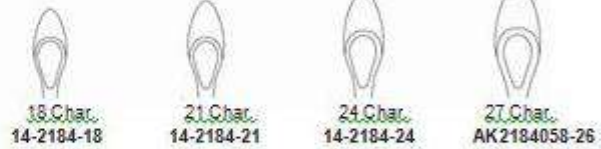



Gallengang Dilatatoren
Common Bile Duct Dilators
Dilatadores para el conducto biliar
Dilatatori per coledoco



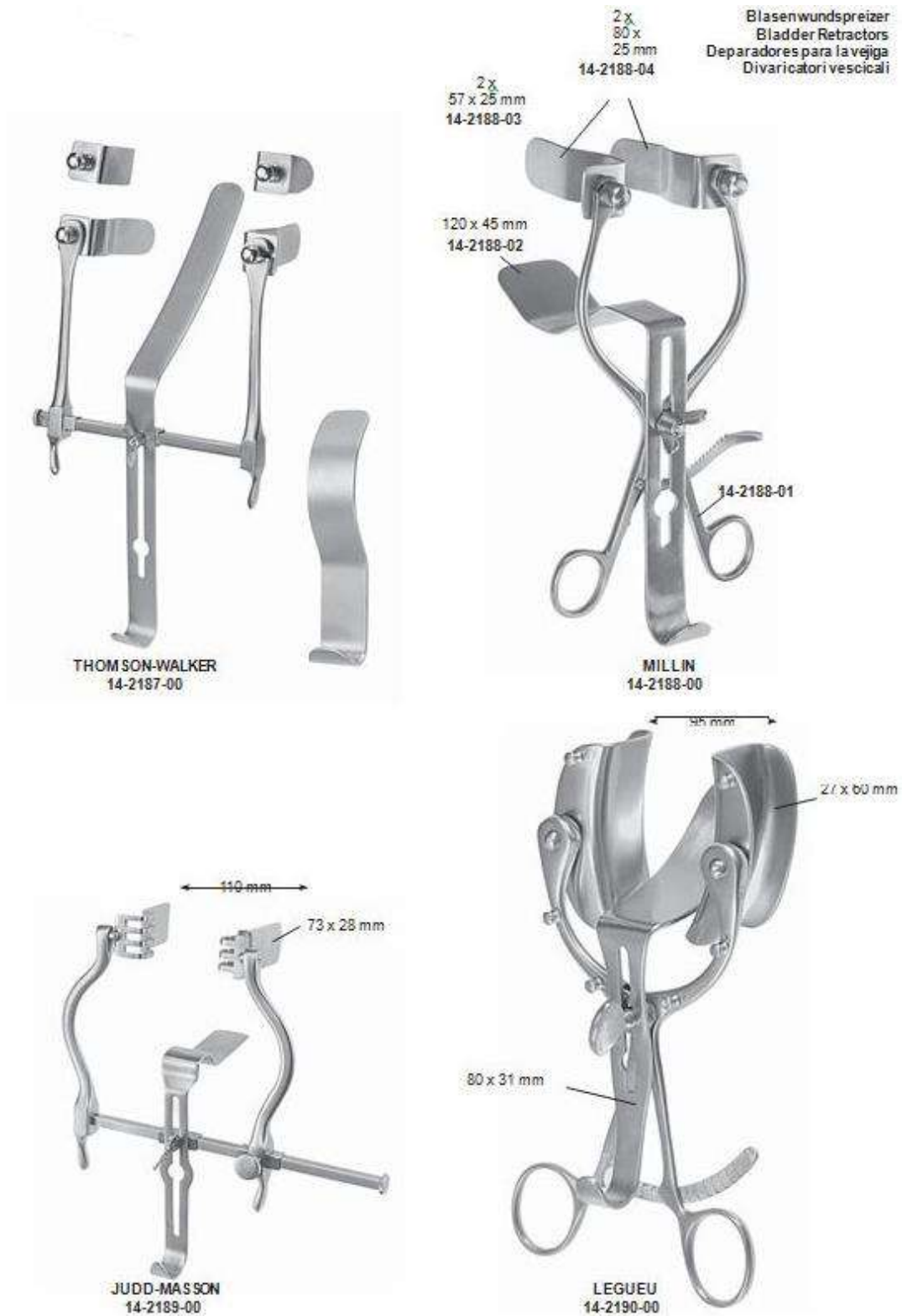



Instrumente für Prostektomie
Prostatectomy Instruments
Instrumentos para la prostatectomia
Strumenti per operazioni della prostata



MILLIN
23,0 cm, 9"
14-2191-23



ATRAUMA

MILLIN
24,0 cm, 9 1/2"
14-2192-24



MILLIN
24,0 cm, 9 1/2"
14-2193-24



MILLIN
23,0 cm, 9"
14-2195-23



MILLIN
28,5 cm, 11 1/4"
14-2196-24



20,0 cm, 8" 14-2197-20
28,0 cm, 11" 14-2197-28

MATHIEU

Prostatahaken, Blasenspatel
 Prostatic Retractors, Bladder Retractor
 Separadores para la prostata,
 Separadores vesicales Retrattori prostatici,
 Divaricatori vescicali



YOUNG
 21,0 cm, 8 1/4"
 14-2198-21



YOUNG
 22,0 cm, 8 1/2"
 14-2199-22



YOUNG
 21,0 cm, 8 1/4"
 14-2200-21



YOUNG
 22,0 cm, 8 1/4"
 14-2201-22



LEGUEU
 26,0 cm, 10 1/4"
 14-2202-26



KOCHER
 23,5 cm, 9 1/4"
 14-2203-23

Katheter, Penis klemmen
 Catheters, Penis Clamp
 Sondas, Compresor urétral
 Cateteri, Serrapene



für Männer
 for men
 para hombres
 per uomini

Char. 8	14-2204-08
Char. 10	14-2204-10
Char. 12	14-2204-12
Char. 14	14-2204-14
Char. 16	14-2204-16
Char. 18	14-2204-18
Char. 20	14-2204-20
Char. 22	14-2204-22
Char. 24	14-2204-24

29,0 cm, 11 1/2"



für Frauen
 women
 para mujeres
 per donne

Char. 6	14-2205-06
Char. 7	14-2205-07
Char. 8	14-2205-08
Char. 9	14-2205-09
Char. 10	14-2205-10
Char. 11	14-2205-11
Char. 12	14-2205-12
Char. 13	14-2205-13
Char. 14	14-2205-14
Char. 15	14-2205-15
Char. 16	14-2205-16
Char. 18	14-2205-18
Char. 20	14-2205-20
Char. 24	14-2205-24

16,0 cm, 6 1/4"



STRAUSS
 11,0 cm, 4 1/8"
 14-2207-11



STOCKMANN
 8,0 cm, 3 1/8"
 14-2208-08



Ø 8,0mm	14-2206-08
Ø 11,0mm	14-2206-11
Ø 13,0 mm	14-2206-13
Ø 16,0mm	14-2206-16
Ø 21,0mm	14-2206-21
Ø 26,0mm	14-2206-26
Ø 32,0 mm	14-2206-32

COMCO



Darm-undGewebeßzangen
 Intestinal and Tissue Grasping Forceps
 Pinzas intestinalesy para tejidos
 Pinze da presa per intestine o etessuti

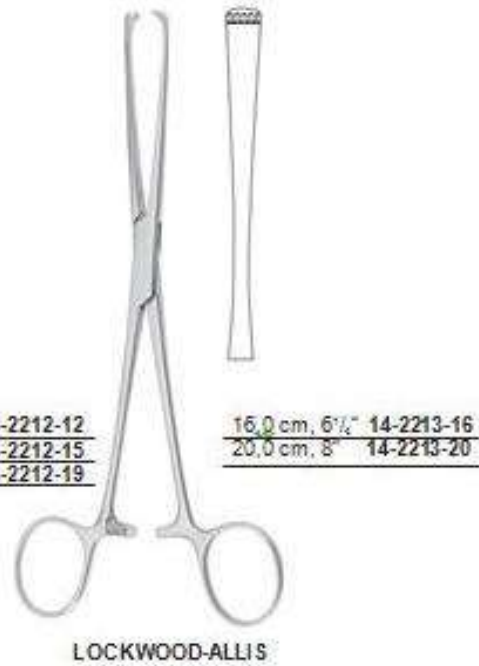

Darm-undGewebeFazangen
 Intestinal and Tissue Grasping Forceps.
 Pinzas intestinales para tejidos
 Pinze da presa per intestine o tessuti



15,0 cm, 6" 14-2214-13
 19,0 cm, 7 1/2" 14-2214-19

JUDD-ALLIS



2 x 3

LITTLEWOOD
 18,5 cm, 7 1/4"
 14-2215-16



10 x 11

ALLIS-ADAIR
 15,5 cm, 6"
 14-2216-15



BOYS-ALLIS
 15,5 cm, 6"
 14-2217-15



6 x 7

THOMS-ALLIS
 20,0 cm, 8"
 14-2218-20



ALLIS
 20,0 cm, 8"
 14-2219-20



Darm-und Gewebefalzangen
Intestinal and Tissue Grasping Forceps
Pinzas intestinales para tejidos
Pinze da presa per intestine o tessuti



LOCKWOOD
20,0 cm, 8"
14-2220-20



WILLIAMS
16,0 cm, 6 1/2"
14-2221-16



BABCOCK

16,0 cm, 6 1/2" 14-2222-16
18,0 cm, 7" 14-2222-18
20,0 cm, 8" 14-2222-20
24,0 cm, 9 1/2" 14-2222-24



BABCOCK-ATRAUMA

16,0 cm, 6 1/2" 14-2223-16
20,0 cm, 8" 14-2223-20



BABCOCK-TC

16,0 cm, 6 1/2" 14-2224-16
20,0 cm, 8" 14-2224-20



DUVAL-TC
20,0 cm, 8"
14-2225-20

Darmklemmen
Intestinal Clamp Forceps
Pinzas-clamps intestinales
Pinze intestinali

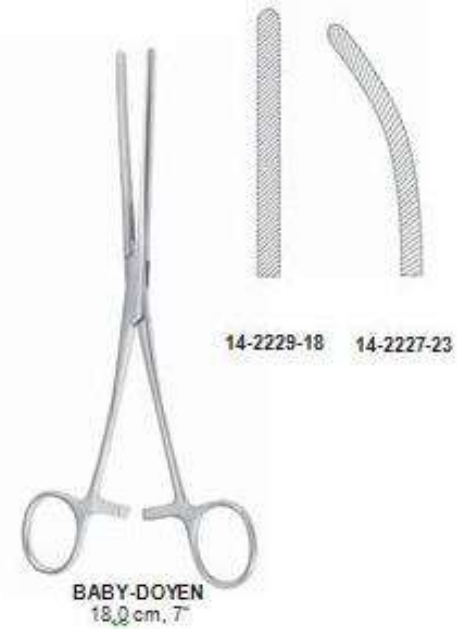



Darmklemmen
Intestinal Clamp Forceps
Pinzas-clamps intestinales
Pinze intestinali



DOYEN



21,0 cm, 8 1/4"	14-2232-21	21,0 cm, 8 1/4"	14-2233-21
23,0 cm, 9"	14-2232-23	23,0 cm, 9"	14-2233-23

mit atraumatischer Zahnung
with atraumatic serration
bicos atraumaticos
morsi atraumatici



KOCHER



22,0 cm, 8 1/2"	14-2234-22	22,0 cm, 8 1/2"	14-2235-22
25,0 cm, 9 1/2"	14-2234-25	25,0 cm, 9 1/2"	14-2235-25
28,0 cm, 11"	14-2234-28	28,0 cm, 11"	14-2235-28

Darmklemmen
 Intestinal Clamp Forceps
 Pinzas-clamps intestinales
 Pinze intestinali



mit atraumatischer Zahnung
 with atraumatic serrationcon
 bocos atraumaticoscon
 morsi atraumatici

KOCHER

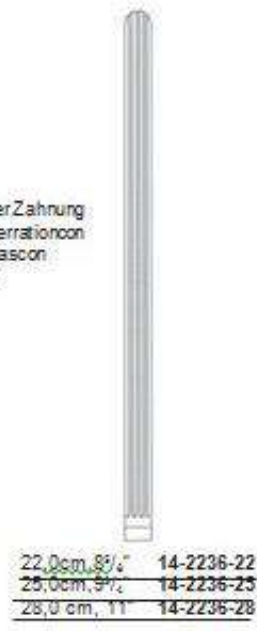

22,0cm, 8 1/2"	14-2236-22
25,0cm, 9 1/2"	14-2236-25
28,0 cm, 11"	14-2236-28



22,0cm, 8 1/2"	14-2237-22
25,0cm, 9 1/2"	14-2237-25
28,0 cm, 11"	14-2237-28



MAYO-ROB SON

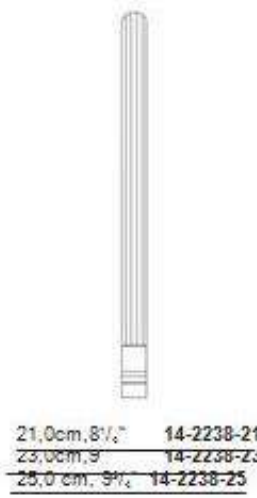

21,0cm, 8 1/2"	14-2238-21
23,0cm, 9"	14-2238-23
25,0 cm, 9 1/2"	14-2238-25



21,0cm, 8 1/2"	14-2239-21
23,0cm, 9"	14-2239-23
25,0 cm, 9 1/2"	14-2239-25



Darmklemmen
Intestinal Clamp Forceps
Pinzas-clamps intestinales
Pinze intestinali



21,0cm, 8 1/2"	14-2240-21	21,0cm, 8 1/2"	14-2241-21
23,0cm, 9"	14-2240-23	23,0cm, 9"	14-2241-23
25,0cm, 9 1/2"	14-2240-25	25,0cm, 9 1/2"	14-2241-25

mit atraumatischer Zahnung
with atraumatic serration
bacos atraumaticos
morsi atraumatici



BRUNNER
24,0 cm, 9 1/2"
14-2242-24

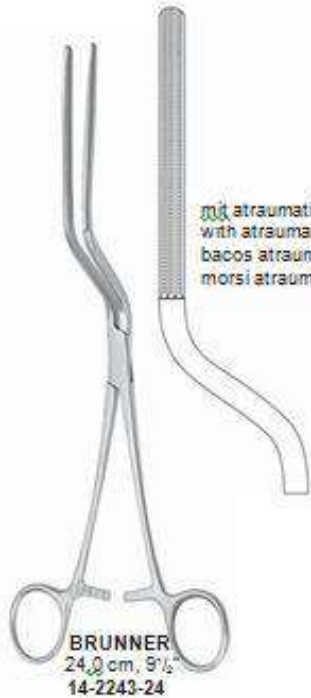

BRUNNER
24,0 cm, 9 1/2"
14-2243-24

mit atraumatischer Zahnung
with atraumatic serration
bacos atraumaticos
morsi atraumatici



GLASSMAN
23,0 cm, 9"
14-2244-23



GLASSMAN
23,5 cm, 9 1/2"
14-2245-23



Darm- und Magenquetschklappen
Intestinal and Stomach Clamps
Pinzas-clamps intestinales y estomacales
Pinze/Clamp per intestino e stomaco



Maullänge
length of jaws
longitud de la boca
bocche lungh.

5,0 cm, 2"	14-2246-05
7,0 cm, 2 7/8"	14-2246-07
10,0 cm, 4"	14-2246-10

DEMARTEL-WOLF SON



DEMARTEL-WOLF SON
8,3 cm, 3 1/8"
14-2247-08



DEMARTEL-WOLF SON
26,0 cm, 10 1/4"
14-2248-26



BABY-PAYR
15,0 cm, 6"



14-2249-15
mit Stift
with pinhead
espiga con
perno



14-2250-15
ohne Stift
without pin
sin espiga
senza perno



PAYR



21,0 cm, 8 1/4"	14-2252-21	14-2253-21
29,0 cm, 11 1/2"	14-2252-29	14-2253-29

mit Stift with pinhead espiga con perno	ohne Stift without pin sin espiga senza perno
---	--



Darm- und Magenklappen
 Intestinal and Stomach Clamp Forceps
 Pinzas-clamps intestinales y estomacales
 Pinze per intestino e stomaco



14-2254-30

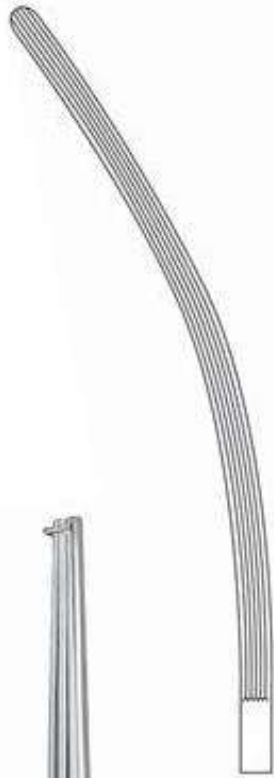

14-2255-30



14-2256-33



14-2257-33

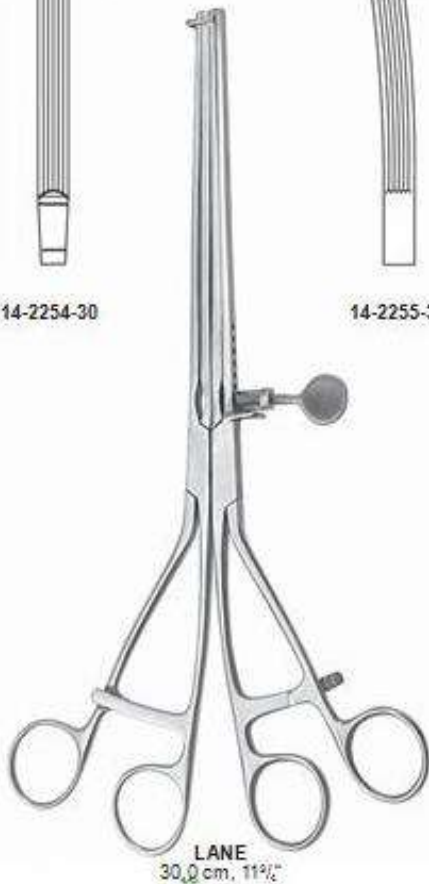

LANE
30,0 cm, 11 1/2"

mit atraumatischer Zahnung
 with atraumatic serration
 bocas atraumaticas con
 morsi atraumatici



SCUDDER
33,0 cm, 13"

Rektum-Anastomosenklemmen
Sigmoid Anastomosis Forceps
Pinzas para anastomosis de recto
Pinze per anastomosi de retto





Mastdarm-Rektum-Spekula
Rectal Specula
Espéculos para el recto
Speculi rectali





ALAN PARKS
13,5 cm, 5 1/4"
14-2265-00

Anal spreizer, Sphinkterskope,
Anuskope Rectal Retractor,
Sphincteroscopes, Anoscope
Separadores para el recto, Esfinteroscopios, Anoscopios
Dilatatori per l'ano ed il retti, Sfinteroscopi, Anoscopi



Kaltlichtkammer für Proktoskope
Cold-light clip for proctoscopes
Clip para luz fría con proctoscopios
Clip per luce fredda con proctoscopi

14-2266-00



Ø22x 50mm	14-2267-01
Ø22x100mm	14-2267-02
Ø22x145mm	14-2267-03
Ø22x200mm	14-2267-04
Ø21x 50mm	14-2267-05
Ø21 x 50 mm	14-2267-06

HAYES



Ø16x 65mm	14-2268-01
Ø19x 65mm	14-2268-02
Ø22x 65mm	14-2268-03
Ø22 x 130 mm	14-2268-04

HIRSCHMANN



Anuskope, Proktoskope
Anoscope, Proctoscopes
Anoscopios, Proctoscopios
Anoscopi, Proctoscopi



Ø 22 x 65 mm 14-2269-22
Ø 30 x 65 mm 14-2269-30

CHEL SEAEATON



ohne Kaltlichttrager
without cold light carrier
sin portador para luz fria
senza luce fredda

IVESFAN SLER
Ø 22 mm
14-2270-01

mit Kaltlichttrager
with cold light carrier
con portador para luz fria
con luce fredda

IVESFAN SLER
Ø 22 mm
14-2271-02



Ø17x6565mm 14-2272-01
Ø17x80mm 14-2272-02
Ø20x65mm 14-2272-03
Ø20x80mm 14-2272-04
Ø24x65mm 14-2272-05
Ø24x80mm 14-2272-06

MORGAN



055-1000-02



Ø25x6565mm 14-2273-25
Ø25x65mm 14-2273-26
Ø38x70mm 14-2273-38

FAN SLER

Mastdarm-Biopsiezangen
Rectal Biopsy Forceps
Pinzas sacabocado para biopsia rectal
Pinze taglianti per biopsia rettale



28,0cm, 11"	14-2274-28
35,0cm, 13 3/4"	14-2274-35
42,0cm, 16 1/2"	14-2274-42



20,0cm, 11"	14-2275-28
35,0cm, 13 3/4"	14-2275-35
42,0cm, 16 1/2"	14-2275-42

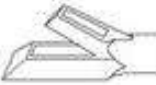

28,0cm, 11"	14-2276-28
35,0cm, 13 3/4"	14-2276-35
42,0cm, 16 1/2"	14-2276-42

14-2278-00



28,0cm, 11"	14-2277-28
35,0cm, 13 3/4"	14-2277-35
42,0cm, 16 1/2"	14-2277-42

14-2279-00

Ø 12,0 mm

Ø 12,0 mm



Hemorroiden-Ligator mit Ladekonus
Haemorrhoidal ligator with loading attachment
Ligador para hemorroides con cono de carga
Legator emorroidali con carica a cono

Hemorroiden-Ligator mit Ladekonus
Haemorrhoidal ligator with loading attachment
Ligador para hemorroides con cono de carga
Legator emorroidali con carica a cono

RUDD
14-2280-00



MCGIVNEY
14-2281-00



Hämorrhoiden-Falßzangen, Fistelsonden
Haemorrhoidal Forceps, Fistula probes
Pinza-clamps para hemorroides, Sondas para fistula
Pinze per emorroidi, Sonde per fistola



MCGIVNEY
19,0 cm, 7 1/2"
14-2282-19



MCGIVNEY
19,0 cm, 7 1/2"
14-2283-19



PRATT
21,0 cm, 8 1/4"



14-2284-01



14-2284-02



14-2284-03



Scheidenspekula
 Vaginal Specula
 Espéculos vaginales
 Speculi vaginali

für
 Kindertor
 children
 para niños
 per bambini



COLLIN
 65 x 10 mm
 14-2285-00

für Jungfrauen
 for virgins para
 virgenes per
 vergini



COLLIN5
 5 x 10 mm
 14-2286-00



COLLIN

85 x 30 mm	14-2287-01
100 x 35 mm	14-2287-02
110 x 40 mm	14-2287-03



CUSCO

80x24mm	14-2288-01
80x32mm	14-2288-02
98x16mm	14-2288-03
105x25mm	14-2288-04
107x29mm	14-2288-05
115 x 35 mm	14-2288-06



Scheidenspekula
Vaginal Specula
Espéculos vaginales
Speculi vaginali

zentrale Stellschraube
central fixation screw
tornillo de sujeto
central vite di regolazione
centrale



CUSCO

75 x 32 mm	14-2289-01
85 x 30 mm	14-2289-02
95 x 37 mm	14-2289-03

seitliche Stellschraube
lateral fixation screw
tornillo de sujeto lateral vite
di regolazione laterale



für Jungfrauen
for virgins para
virgenes per
vergini

CUSCO
75 x 17 mm
14-2290-00

seitliche Stellschraube
lateral fixation screw
tornillo de sujeto
lateral vite di regolazione
laterale



CUSCO

75 x 32 mm	14-2291-01
85 x 35 mm	14-2291-02
100 x 35 mm	14-2291-03

Schweizer Model
Swiss pattern
Modelo suizo
Modello svizzero



CUSCO

90 x 23-25 mm	14-2292-01
100 x 25-27 mm	14-2292-02
110 x 27-30 mm	14-2292-03

Scheidenspekula
 Vaginal Specula
 Espéculos vaginales
 Speculi vaginali



GRAVE
 75 x 20 mm 14-2293-01
 95 x 35 mm 14-2293-02
 115 x 35 mm 14-2293-03



PEDERSON
 75 x 13 mm 14-2294-01
 100 x 22 mm 14-2294-02
 120 x 25 mm 14-2294-03



SEMM
 90 x 14-18 mm 14-2295-01
 100 x 17-20 mm 14-2295-02
 100 x 25-30 mm 14-2295-03



WEISSBARTH
 21,0 cm, 8 1/4"
 14-2296-00

Scheidenspekula
Vaginal Specula
Especulos vaginales
Speculi vaginali



mit abnehmbarem Gewicht
with detachable weight
peso desmontable
peso smontabile

1,14 kg

AUVARD
75 x 38 mm
14-2297-00



mit festem Gewicht
with fixed weight
con peso fijo
con peso fisso

1,14 kg

AUVARD
75 x 38 mm
14-2298-00



14-2299-03

400 g
14-2299-40

800 g
14-2299-80

SCHERBACK
14-2299-00

koplett, complete, completo, completo



80 x 30 mm
14-2299-04



85 x 35 mm
14-2299-05



85 x 40 mm
14-2299-06



85 x 40-60 mm
14-2299-07



100 x 45-100 mm
14-2299-08



Scheidenspekula
Vaginal Specula
Espéculos vaginales
Speculi vaginali



Satz
Set
Juego
Set

KRISTELLER
Fig. 1 14-2300-01
Fig. 2 14-2300-02
Fig. 3 14-2300-03



Spekula allein, flach
Specula only, flat hollow
Espéculos suelto, con huecos planos
Solo speculi, piatta

KRISTELLER
105 x 26 mm 14-2301-01
105 x 28 mm 14-2301-02
105 x 33 mm 14-2301-03



Halter allein
Retractors only
Valvas suelto
Solo valve

KRISTELLER
115 x 22 mm 14-2302-01
115 x 24 mm 14-2302-02
115 x 29 mm 14-2302-03



Satz
Set
Juego
Set

KRISTELLER
Fig. 1 14-2303-01
Fig. 2 14-2303-02
Fig. 3 14-2303-03



Spekula allein, flach
Specula only, flat hollow
Espéculos suelto, con huecos planos
Solo speculi, piatta

KRISTELLER
110 x 27 mm 14-2304-01
110 x 30 mm 14-2304-02
110 x 36 mm 14-2304-03



Halter allein
Retractors only
Valvas suelto
Solo valve

KRISTELLER
115 x 23 mm 14-2305-01
115 x 26 mm 14-2305-02
115 x 32 mm 14-2305-03

Scheidenspekula
Vaginal Specula
Espéculos vaginales
Speculi vaginali



Satz
Set
Juego
Set

KRISTELLER
Fig. 0 14-2306-00
Fig. 1 14-2306-01
Fig. 2 14-2306-02
Fig. 3 14-2306-03



Spekula allein
Specula only
Espéculos sueltos
Solo speculi

KRISTELLER
70 x 15 mm 14-2307-00
70 x 27 mm 14-2307-01
80 x 30 mm 14-2307-02
90 x 36 mm 14-2307-03



Halter allein
Retractors only
Valvas sueltos
Solo valve

KRISTELLER
75 x 10 mm 14-2308-00
75 x 23 mm 14-2308-01
85 x 26 mm 14-2308-02
100 x 32 mm 14-2308-03



konisch, für Jungfrauen
conical blades, for virgins
valvas cónicas, para vírgenes
valve coniche, per vergini

Satz
Set
Juego
Set

KRISTELLER
Fig. 00 14-2309-01
Fig. 00 14-2309-02



Spekula allein
Specula only
Espéculos sueltos
Solo speculi

KRISTELLER
105 x 18 mm 14-2310-01
105 x 27 mm 14-2310-02



Halter allein
Retractors only
Valvas sueltos
Solo valve

KRISTELLER
110 x 14 mm 14-2311-01
110 x 17 mm 14-2311-02

Scheidenspekula
Vaginal Specula
Especulos vaginales
Speculi vaginali



leicht hohl
slightly-concave
leggeremente concavos
leggeremente concavi

Fig	axb	
1	55 x 35 mm	14-2312-01
2	85 x 35 mm	14-2312-02
3	115 x 35 mm	14-2312-03

1	55 x 45 mm	14-2313-01
2	85 x 45 mm	14-2313-02
3	115 x 45 mm	14-2313-03
4	160 x 45 mm	14-2313-04

1	55 x 60 mm	14-2314-01
2	85 x 60 mm	14-2314-02
3	115 x 60 mm	14-2314-03
4	160 x 60 mm	14-2314-04

DOYEN
23,0 cm, 9"



halb-
hohlmedium-
concave semi-
concavos semi-
concavi

Fig	axb	
1	55 x 35 mm	14-2315-01
2	85 x 35 mm	14-2315-02
3	115 x 35 mm	14-2315-03

1	55 x 45 mm	14-2316-01
2	85 x 45 mm	14-2316-02
3	115 x 45 mm	14-2316-03

1	55 x 60 mm	14-2317-01
2	85 x 60 mm	14-2317-02
3	115 x 60 mm	14-2317-03

DOYEN
23,0 cm, 9"

Scheidenspekula
Vaginal Specula
Espéculos vaginales
Speculi vaginali



Satz
Set
Juego
Set

KALLMORGEN
70 x 40 mm 14-2318-01
90 x 40 mm 14-2318-02



Spekula allein
Specula only
Espéculos sueltos
Solo speculi

KALLMORGEN
70 x 40 mm 14-2319-01
90 x 40 mm 14-2319-02



Halter allein
Retractors only
Valvas sueltos
Solo valve

KALLMORGEN
70 x 40 mm 14-2320-01
90 x 40 mm 14-2320-02



70 x 15 mm

KRISTELLER
17,0 cm, 6 1/2"
14-2321-17



75 x 39 mm

KALLMORGEN
17,0 cm, 6 1/2"
14-2322-17



JACKSON
75 x 38 mm 14-2323-01
90 x 38 mm 14-2323-02
100 x 38 mm 14-2323-03

Scheidenspekula
Vaginal Specula
Espéculos vaginales
Speculi vaginali
16 x 25 mm



BREISKY
14,0 cm, 5½"
14-2324-01

82 x 30 mm



BREISKY
14,0 cm, 5½"
14-2324-02

95 x 38 mm



BREISKY
17,0 cm, 6¾"
14-2324-03

102 x 44 mm



BREISKY
17,0 cm, 6¾"
14-2324-04

Scheidenspekula und -halter
 Vaginal Specula and Retractors
 Espéculos y valvas vaginales
 Speculi e valve vaginali

SIMSGO
 14-1294-00
 Satz, Set, Juego, Set



SIMS
 12,5 cm, 5"
 14-2325-01



SIMS
 15,0 cm, 6"
 14-2325-02



SIMS
 17,5 cm, 7"
 14-2325-03



MATHIEU
 100 x 13-23 mm 14-2326-01
 100 x 16-30 mm 14-2326-02



MATHIEU
 100 x 11-21 mm 14-2327-01
 100 x 14-27 mm 14-2327-02



LANDAU
 100 x 28 mm 14-2328-01
 100 x 38 mm 14-2328-02

Scheidenspekula
Vaginal Specula
Espéculos vaginales
Speculi vaginali



BREISKY

100x20mm	14-2329-20
100x25mm	14-2329-25
100x30mm	14-2329-30
100x35mm	14-2329-35
100x40mm	14-2329-40
130x20mm	14-2330-20
130x25mm	14-2330-25
130x30mm	14-2330-30
130x35mm	14-2330-35
130x40mm	14-2330-40
155x40mm	14-2331-40

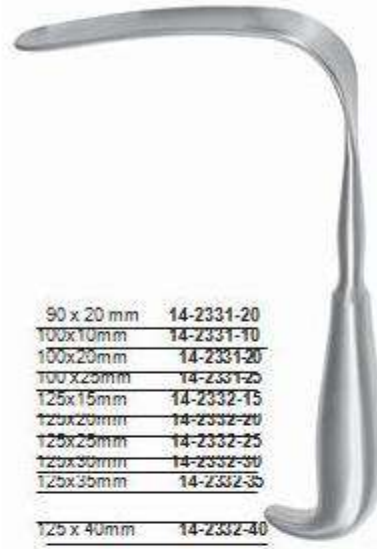

MATZENAUER

90 x 20 mm	14-2331-20
100x10mm	14-2331-10
100x20mm	14-2331-20
100x25mm	14-2331-25
125x15mm	14-2332-15
125x20mm	14-2332-20
125x25mm	14-2332-25
125x30mm	14-2332-30
125x35mm	14-2332-35
125 x 40mm	14-2332-40



BRAUN,MODIE.
19,0 cm, 7 1/2"
14-2333-19



DOYEN
23,0 cm, 9"
14-2333-23



DOYEN
25,0 cm, 9"
14-2333-25



WERTHEIM
30,0 cm, 12"
14-2333-30

Endospekula, Lateral-Spekulum,
 ntrauterinsonde Endospecula, Lateral
 Speculum, Intrauterine Probe Endoespéculos,
 Espéculo lateral, Sonda intra-uterina
 Endospeculi, Speculo lateral, Sonde intrauterine

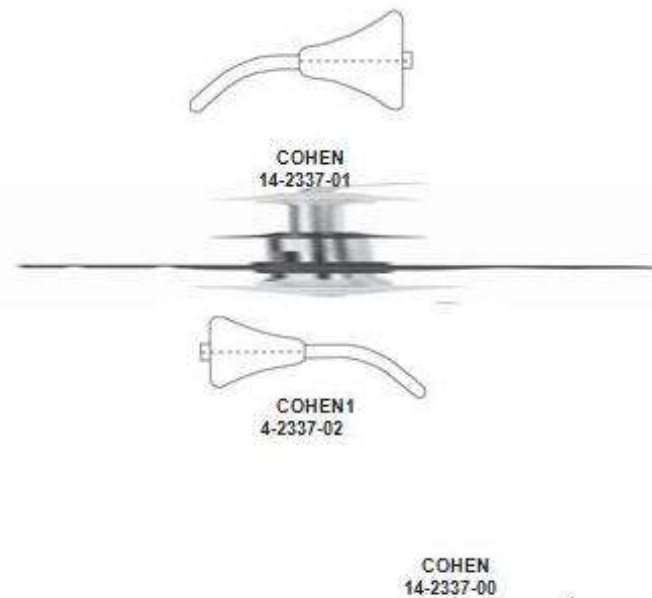
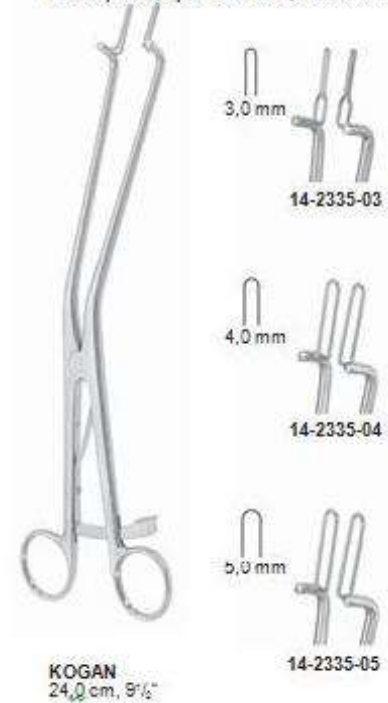



Uterus-Dilatatoren
Uterine Dilators
Dilatadores uterinos
Dilatatori uterini



HEGAR
18,5 cm, 7 1/2"

Ø 1,0 mm	14-2338-01
Ø 2,0 mm	14-2338-02
Ø 3,0 mm	14-2338-03
Ø 4,0 mm	14-2338-04
Ø 5,0 mm	14-2338-05
Ø 6,0 mm	14-2338-06
Ø 7,0 mm	14-2338-07
Ø 8,0 mm	14-2338-08
Ø 9,0 mm	14-2338-09
Ø 10,0 mm	14-2338-10
Ø 11,0 mm	14-2338-11
Ø 12,0 mm	14-2338-12
Ø 13,0 mm	14-2338-13
Ø 14,0 mm	14-2338-14
Ø 15,0 mm	14-2338-15
Ø 16,0 mm	14-2338-16
Ø 17,0 mm	14-2338-17
Ø 18,0 mm	14-2338-18
Ø 19,0 mm	14-2338-19
Ø 20,0 mm	14-2338-20
Ø 21,0 mm	14-2338-21
Ø 22,0 mm	14-2338-22
Ø 23,0 mm	14-2338-23
Ø 24,0 mm	14-2338-24
Ø 25,0 mm	14-2338-25
Ø 26,0 mm	14-2338-26



HEGAR
18,5 cm, 7 1/2"

Ø 1,5 mm	14-2339-01
Ø 2,5 mm	14-2339-02
Ø 3,5 mm	14-2339-03
Ø 4,5 mm	14-2339-04
Ø 5,5 mm	14-2339-05
Ø 6,5 mm	14-2339-06
Ø 7,5 mm	14-2339-07
Ø 8,5 mm	14-2339-08
Ø 9,5 mm	14-2339-09
Ø 10,5 mm	14-2339-10
Ø 11,5 mm	14-2339-11
Ø 12,5 mm	14-2339-12
Ø 13,5 mm	14-2339-13
Ø 14,5 mm	14-2339-14
Ø 15,5 mm	14-2339-15
Ø 16,5 mm	14-2339-16
Ø 17,5 mm	14-2339-17



205 x 105 x 45 mm

HEGAR
14-2340-99
Satz, Set, Juego, Set
Ø 1,0 - Ø 26,0(26
dilators)

HEGAR
14-2340-98
Satz, Set, Juego, Set
Ø 4,0 - Ø 17,0
(14 dilators)

Uterus-Dilatatoren
 Uterine Dilators
 Diladores uterinos
 Dilattatori uterini



HEGAR
 20,0 cm, 8"

1,0/ 2,0mm	14-2341-01
Ø 3,0/ 4,0mm	14-2341-03
Ø 5,0/ 6,0mm	14-2341-05
Ø 7,0/ 8,0mm	14-2341-07
Ø 9,0/10,0mm	14-2341-09
Ø11,0/12,0mm	14-2341-11
Ø13,0/14,0mm	14-2341-13
Ø15,0/16,0mm	14-2341-15
Ø17,0/18,0mm	14-2341-17
Ø19,0/20,0mm	14-2341-19
Ø21,0/22,0mm	14-2341-21
Ø23,0/24,0mm	14-2341-23
Ø 25,0 / 26,0mm	14-2341-25



HEGAR
 14-2342-98
 Satz, Set, Juego, Set
 Ø 3,0 / 4,0 - Ø 17,0 / 18,0 mm
 (8 dilators)

HEGAR
 14-2343-99
 Satz, Set, Juego, Set
 Ø 1,0 / 2,0 - Ø 25,0 / 26,0 mm
 (13 dilators)



HANK

Ø4,5/ 5,0mm	14-2344-05
Ø5,5/ 6,0mm	14-2344-06
Ø6,5/ 7,0mm	14-2344-07
Ø7,5/ 8,0mm	14-2344-08
Ø8,5/ 9,0mm	14-2344-09
Ø 9,5 / 10,0 mm	14-2344-10



HANK
 14-2345-98
 Satz, Set, Juego, Set
 Ø 4,5 / 5,0 - Ø 9,5 / 10,0 mm
 (6 dilators)



Uterus-Dilatatoren, Hakenzangen
 Uterine Dilators, Uterine Tenaculum Forceps
 Dilatadores uterinos, Pinzas para coger el cuello del útero
 Dilatatori uterini, Pinze per abbassare il collo dell'utero



∅ 4,5/ 6,0mm	14-2346-05
∅ 5,5/ 6,0mm	14-2346-06
∅ 7,5/ 8,0mm	14-2346-08
∅ 8,5/ 9,0mm	14-2346-09
∅ 9,5/10,0mm	14-2346-10
∅11,5/12,0mm	14-2346-12
∅12,5/13,0mm	14-2346-13
∅ 13,5/ 14,0 mm	14-2346-14

PRATT



PRATT
 14-2347-98
 Satz, Set, Juego, Set
 ∅ 4,5 / 5,0 - ∅ 13,5 / 14,0 mm
 (8 dilators)



BARRETT
 18,0 cm, 7"
 14-2348-18



ADAIR
 19,0 cm, 7 1/2"
 14-2349-19



STAUDE-MOORE
 17,0 cm, 6 3/4"
 14-2350-17



Hakenzangen
Uterine Tenaculum Forceps
Pinzas para coger el cuello del útero
Pinze per abbassare il collo dell'utero



JARCHO
20,0 cm, 8"
14-2351-20



SCHROEDER
25,0 cm, 9 1/2"
14-2352-25



BRAUN
25,0 cm, 9 1/2"
14-2353-25



DUPLAY
28,0 cm, 11"
14-2354-28



POZZI
26,0 cm, 10 1/2"
14-2355-26



KAHN
24,0 cm, 9 1/2"
14-2356-24



Hakenzangen
Uterine Tenaculum Forceps
Pinzas para coger el cuello del útero
Pinze per abbassare il collo dell'utero



SKENE
24,0 cm, 9 1/2"
14-2357-24



SCHROEDER
24,0 cm, 9 1/2"
14-2358-24



SCHROEDER
24,0 cm, 9 1/2"
14-2359-24



TEALE
23,0 cm, 9"
14-2360-23



JACOBS
21,0 cm, 8 1/2"
14-2361-21



JACOBS
21,0 cm, 8 1/2"
14-2362-21

Hakenzangen
 Uterine Tenaculum Forceps
 Pinzas para coger el cuello del útero
 Pinze per abbassare il collo dell'utero

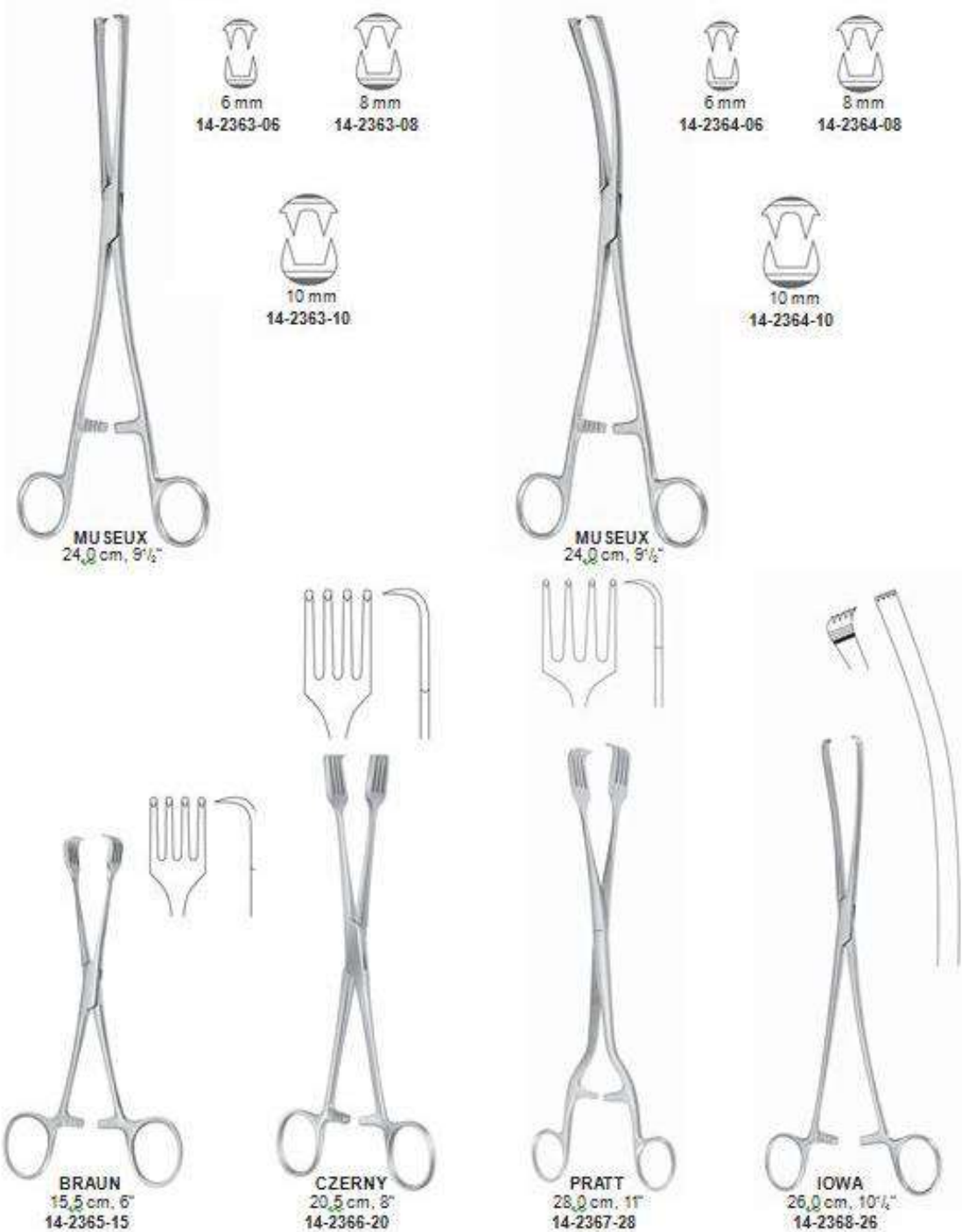



Polypen- und Ovarienzangen, Uterusfaßzangen
Polypus and Ovum Forceps, Uterine Elevating Forceps
Pinzas para pólipos uterinos y ovarios, Pinzas para la útero
Pinze per polipi e ovaie, Pinze per affarrare l'utero





Uterusfaßzangen, Uterussonden,
Zentimetereinteilung
Uterine Elevating Forceps, Uterine Probes, graduated in centimeters
Pinzas para la útero, Histerómetros, graduado en centímetros
Pinze per afferrare l'utero, Isterometri, graduato in cm



COLLIN
26,0 cm, 10 1/4"
14-2375-25



Amniotom
Amniotome
Amniotomo
Amniotomo

BEACHAM
26,0 cm, 10 1/4"
14-2376-26



Uterus-Depressor
Uterine depressor
Depressor uterino
Depressor uterini

BRAUN
28,0 cm, 11"
14-2377-28



SIMS
32,0 cm, 12 1/2"
14-2378-32



Bogsam,
malleable
malleable
malleabile

SIMS
32,0 cm, 12 1/2"
14-2379-32



MARTIN
32,0 cm, 12 1/2"
14-2380-32

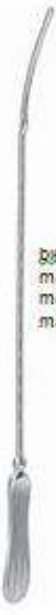

Bogsam,
malleable
malleable
malleabile

MARTIN
32,0 cm, 12 1/2"
14-2381-32



VALLEIX
25,0 cm, 10"
14-2382-25

Ø 4 mm



SIMPSON
29,0 cm, 11 1/2"
14-2383-29

Ø 4 mm



COLLIN
28,0 cm, 11"
14-2384-28

Biopsieküretten
Biopsy Curettes
Curetas para biopsia
Curette per biopsia



KEVORKIAN
30,0 cm, 12"
14-2385-30



KEVORKIAN
30,0 cm, 12"
14-2386-30



KEVORKIAN
30,0 cm, 12"
14-2387-30



NOVAK
23,0 cm, 9"
14-2391-04



RANDALL
23,0 cm, 9"
14-2392-04



MILAN
29,0 cm, 11 1/2"



Ø 4 mm
14-2388-04



Ø 4 mm
14-2389-04



Ø 4 mm
14-2390-04



Myominstrumente
Myoma Instruments
Instrumentos para mioma
Strumenti per fibroma



UTERUSPERFORATOR
25,0 cm, 9 1/2"
14-2393-25



FISTELHAKEN
25,0 cm, 9 1/2"
14-2394-25



SIMON
22,0 cm, 8 1/2"
14-2395-22



EMMETT
22,0 cm, 8 1/2"



14-2396-01



14-2396-02



14-2396-03



14-2396-04



14-2396-05



SEGOND
27,0 cm, 10 1/2"
14-2397-27



AYRE
23,0 cm, 9"
14-2397-23



DOYEN
19,0 cm, 7 1/2"
14-2397-01



DOYEN
17,0 cm, 6 1/2"
14-2397-02

Uterusküretten
 Uterine Curettes
 Curetas uterinas
 Curette uterine



scharf, festsharp
 rigid cortantes,
 rigidas acute,
 rigide

Fig. 00	14-2398-05
Fig. 0	14-2398-06
Fig. 1	14-2398-07
Fig. 2	14-2398-08
Fig. 3	14-2398-09
Fig. 4	14-2398-11
Fig. 5	14-2398-12
Fig. 6	14-2398-14
Fig. 7	14-2398-15
Fig. 8	14-2398-16
Fig. 9	14-2398-19
Fig. 10	14-2398-20
Fig. 11	14-2398-21
Fig. 12	14-2398-23

RECAMIER
 26,0 cm, 10 1/4"



scharf, biegsam
 sharp, malleable
 cortantes, maleable
 acute, malleable

Fig. 00	14-2399-05
Fig. 0	14-2399-06
Fig. 1	14-2399-07
Fig. 2	14-2399-08
Fig. 3	14-2399-09
Fig. 4	14-2399-11
Fig. 5	14-2399-12
Fig. 6	14-2399-14
Fig. 7	14-2399-15
Fig. 8	14-2399-16
Fig. 9	14-2399-19
Fig. 10	14-2399-20
Fig. 11	14-2399-21
Fig. 12	14-2399-23

RECAMIER
 26,0 cm, 10 1/4"

Uterusküretten
 Uterine Curettes
 Curetas uterinas
 Curette uterine



scharf, festsharp,
 rigid cortantes,
 rigidas acute,
 rigide

scharf, biegsam
 sharp, malleable
 cortantes, malleable
 acute, malleable

Fig. 00	14-2400-05
Fig. 0	14-2400-06
Fig. 1	14-2400-07
Fig. 2	14-2400-08
Fig. 3	14-2400-09
Fig. 4	14-2400-11
Fig. 5	14-2400-12
Fig. 6	14-2400-14
Fig. 7	14-2400-15
Fig. 8	14-2400-16
Fig. 9	14-2400-19
Fig. 10	14-2400-20
Fig. 11	14-2400-21
Fig. 12	14-2400-23

Fig. 00	14-2401-05
Fig. 0	14-2401-06
Fig. 1	14-2401-07
Fig. 2	14-2401-08
Fig. 3	14-2401-09
Fig. 4	14-2401-11
Fig. 5	14-2401-12
Fig. 6	14-2401-14
Fig. 7	14-2401-15
Fig. 8	14-2401-16
Fig. 9	14-2401-19
Fig. 10	14-2401-20
Fig. 11	14-2401-21
Fig. 12	14-2401-23



SIMS
 26,0 cm, 10 1/4"



SIMS
 26,0 cm, 10 1/4"



Uterusküretten
Uterine Curettes
Curetas uterinas
Curette uterine



scharf, festshap,
rigid cortantes,
rigidas acute,
rigide

Fig. 00	14-2402-05
Fig. 0	14-2402-06
Fig. 1	14-2402-07
Fig. 2	14-2402-08
Fig. 3	14-2402-09
Fig. 4	14-2402-11
Fig. 5	14-2402-12
Fig. 6	14-2402-14
Fig. 7	14-2402-15
Fig. 8	14-2402-16
Fig. 9	14-2402-19
Fig. 10	14-2402-20
Fig. 11	14-2402-21
Fig. 12	14-2402-23

RECAMIER
31,0 cm, 12 1/4"



scharf, biegsam
sharp, malleable
cortantes, maleable
acute, malleable

Fig. 00	14-2403-05
Fig. 0	14-2403-06
Fig. 1	14-2403-07
Fig. 2	14-2403-08
Fig. 3	14-2403-09
Fig. 4	14-2403-11
Fig. 5	14-2403-12
Fig. 6	14-2403-14
Fig. 7	14-2403-15
Fig. 8	14-2403-16
Fig. 9	14-2403-19
Fig. 10	14-2403-20
Fig. 11	14-2403-21
Fig. 12	14-2403-23

RECAMIER
31,0 cm, 12 1/4"

Uterusküretten
Uterine Curettes
Curetas uterinas
Curette uterine



scharf, festsharp,
rigid cortantes,
rigidas acute,
rigide

scharf, biegsam
sharp, malleable
cortantes, malleable
acute, malleable



SIMS
31,0 cm, 12 1/4"

Fig. 00	14-2404-05
Fig. 0	14-2404-06
Fig. 1	14-2404-07
Fig. 2	14-2404-08
Fig. 3	14-2404-09
Fig. 4	14-2404-11
Fig. 5	14-2404-12
Fig. 6	14-2404-14
Fig. 7	14-2404-15
Fig. 8	14-2404-16
Fig. 9	14-2404-19
Fig. 10	14-2404-20
Fig. 11	14-2404-21
Fig. 12	14-2404-23



SIMS
31,0 cm, 12 1/4"

Fig. 00	14-2405-05
Fig. 0	14-2405-06
Fig. 1	14-2405-07
Fig. 2	14-2405-08
Fig. 3	14-2405-09
Fig. 4	14-2405-11
Fig. 5	14-2405-12
Fig. 6	14-2405-14
Fig. 7	14-2405-15
Fig. 8	14-2405-16
Fig. 9	14-2405-19
Fig. 10	14-2405-20
Fig. 11	14-2405-21
Fig. 12	14-2405-23

Uterusküretten
 Uterine Curettes
 Curetas uterinas
 Curette uterine

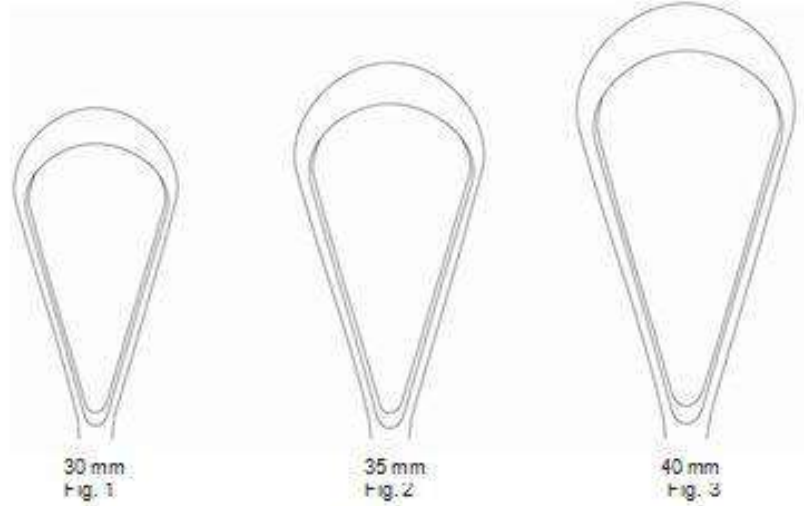

scharf, festsharp,
 rigid cortantes,
 rigidas acute,
 rigide

Fig. 1	14-2406-30
Fig. 2	14-2406-35
Fig. 3	14-2406-40

SIMS

31,0 cm, 12¹/₄"



scharf, biegsam
 sharp, malleable
 cortantes, malleable
 acute, malleable

Fig. 1	14-2407-30
Fig. 2	14-2407-35
Fig. 3	14-2407-40

SIMS

31,0 cm, 12¹/₄"

Uterusküretten
 Uterine Curettes
 Curetas uterinas
 Curette uterine

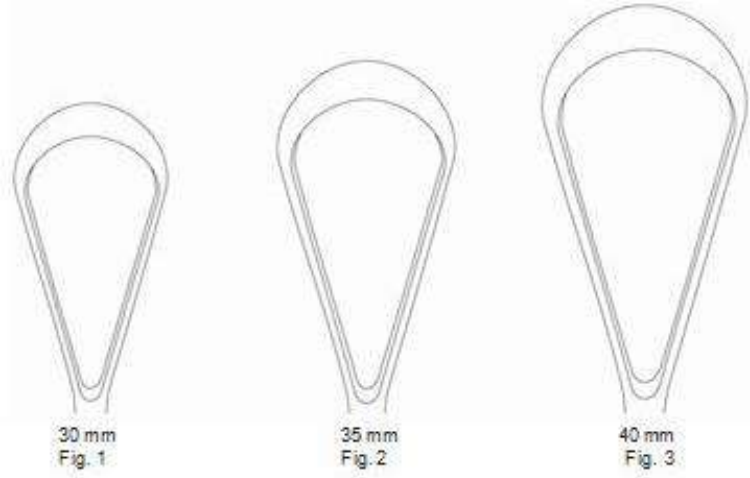

scharf, festsharp,
 rigid cortantes,
 rigidas acute,
 rigide

Fig. 1	14-2408-30
Fig. 2	14-2408-35
Fig. 3	14-2408-40

BUMM
 31,0 cm, 12 1/4"



scharf, biegsam
 sharp, malleable
 cortantes, malleable
 acute, malleable

Fig. 1	14-2409-30
Fig. 2	14-2409-35
Fig. 3	14-2409-40

BUMM
 31,0 cm, 12 1/4"



Uteruslöffel, Uterus-Biopsiezangen Uterine Scoopes,
 Cervical Biopsy and Specimen Forceps
 Cucharillas uterinas, Pinzas saca-bocados para biopsia
 Curette uterine, Pinze per la biopsia cervicale e da prelievo



BLAKE
 27,0 cm, 10 1/2"
 14-2411-27



SIMON
 25,0 cm, 9 1/2"



THOMAS-GAYLOR
 22,0 cm, 8 1/2" 14-2412-22
 24,0 cm, 9 1/2" 14-2412-24



SCHUBERT
 21,0 cm, 8 1/4" 14-2413-21
 29,0 cm, 11 1/2" 14-2413-29



SCHUMACHER-VANDOREN
 24,0 cm, 9 1/2" 14-2414-24

Uterus-Biopsiezangen
Cervical Biopsy and Specimen Forceps
Pinças saca-bocados para biopsia
Pinze per la biopsia cervicale e da prelievo



THOMS-GAYLOR
24,0 cm, 9 1/2"
14-2415-24



FAURE
21,0 cm, 8 1/4"
14-2416-21



SCHUBERT
26,0 cm, 10 1/4"
14-2417-26

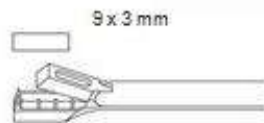

KEVORKIAN
25,0 cm, 10"
14-2418-25

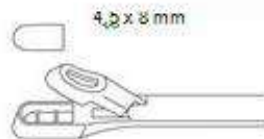

EPPENDORFER
20,0 cm, 8"
14-2419-20



SCHUMACHER
24,0 cm, 9 1/2"
14-2422-06



ALEXANDER
28,0 cm, 11"
14-2420-28

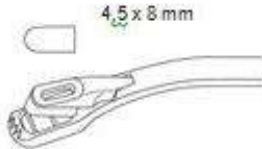

WITTNER
23,0 cm, 9"
14-2423-23



SCHUMACHER
24,0 cm, 9 1/2"
14-2421-04



WITTNER
23,0 cm, 9"
14-2424-23

Uterus-Biopsiezangen
 Cervical Biopsy and Specimen Forceps
 Pinzas saca-bocados para biopsia
 Pinze per la biopsia cervicale e da prelievo

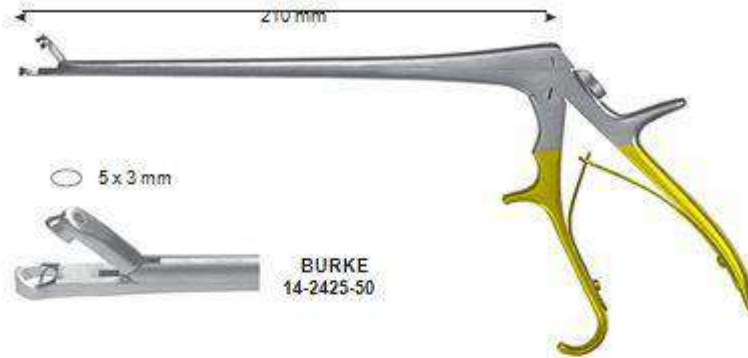

Geburtszangen
 Obstetrical Forceps
 Fórceps para obstétrica
 Forbici per ostetricia



WRIGLEY
 28,0 cm, 11"
 14-2431-28



SIMPSON
 30,0 cm, 11 1/2"
 14-2432-30



SIMPSON-BRAUN
 33,0 cm, 13"
 14-2433-33



SIMPSON-BRAUN
 36,0 cm, 14 1/2"
 14-2434-36



SIMPSON-LUIKART
 36,0 cm, 14 1/2"
 14-2435-36



DELEE
 30,0 cm, 11 1/2"
 14-2436-30



DELEE
 36,0 cm, 14 1/2"
 14-2437-36



DELEE
 38,0 cm, 15 1/4"
 14-2438-38

Geburtszangen
 Obstetrical Forceps
 Fórceps para obstétrica
 Forbici per ostetricia



MCLEAN
 36,0 cm, 14 $\frac{1}{2}$ "
 14-2439-36



KIELAND
 41,0 cm, 16"
 14-2440-41



KIELAND-LIJKART
 40,0 cm, 15 $\frac{1}{2}$ "
 14-2441-40



PIPER
 44,0 cm, 17 $\frac{1}{2}$ "
 14-2442-44



ELLIOT
 32,0 cm, 12 $\frac{1}{2}$ "
 14-2443-32



ELLIOT
 38,0 cm, 15"
 14-2444-38



NAEGELE
 36,0 cm, 14 $\frac{1}{2}$ "
 14-2445-36



NAEGELE
 40,0 cm, 15 $\frac{1}{2}$ "
 14-2446-40

Geburtszangen, Plazentar- und Abortuszangen
 Obstetrical Forceps, Placenta and Ovum Forceps
 Fórceps para obstrétrica, Pinzas para aborto y placenta
 Forbici per ostetricia, Pinze per placenta e per ovaie



GREEN-ARMYTAGE
 21,0 cm, 8 1/4"
 14-2447-21



PESTALOZZA
 30,0 cm, 11 3/4"
 14-2448-30

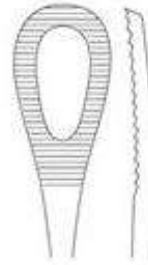

SAENGER
 27,0 cm, 10 3/4"
 14-2449-27



SAENGER
 27,0 cm, 10 3/4"
 14-2450-27



WINTER
 28,0 cm, 11"



Fig. 1
 14-2451-01



Fig. 2
 14-2451-02



Fig. 3
 14-2451-03



Fig. 1
 14-2452-01



Fig. 2
 14-2452-02



Fig. 3
 14-2452-03



Plazentar- und Abortuszangen
Placenta and Ovum Forceps
Pinzas para aborto y placenta
Pinze per placenta e per ovaie



WALLICH
42,0 cm, 16 1/2"
14-2453-42



MARTIN
34,0 cm, 13 1/4"
14-2454-34



BIERER
33,0 cm, 13"
14-2455-01



BIERER
33,0 cm, 13"
14-2456-02



BIERER
33,0 cm, 13"
14-2457-01



BIERER
33,0 cm, 13"
14-2458-02

Hautstanzen, Nagel Instrumente
 Dermal Punches, Nail Instruments
 Trépanos cutáneos, Instrumentos para uñas
 Trapani dermatici, Strumenti per unghie



Lupusküretten
 Lupus curettes
 Curetas para lupus
 Raschiatoio per lupus



PIFFARD
14,0 cm, 5¹/₄"



KEYES
12,0 cm, 4¹/₄"



KEYES
12,0 cm, 4¹/₄"
14-2461-00

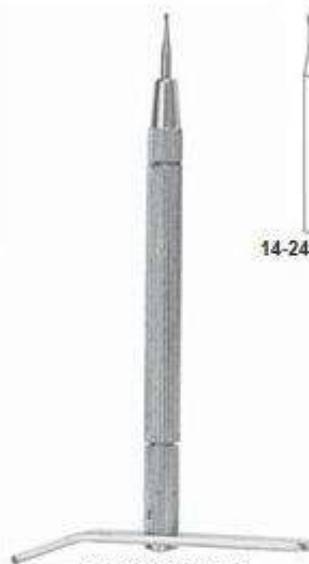

NAGELBOHRER
14-2462-00
komplett, complete,
completo, completo

Komedonenquetscher
Comedo Extractors
Saca-comedones
Tiracomedoni



UNNA
14,0 cm, 5 1/2"
14-2463-14



UNNA
14,0 cm, 5 1/2"
14-2464-14



SAALFELD
10,0 cm, 4"
14-2465-10



SAALFELD
14,0 cm, 5 1/2"
14-2466-14



SCHAMBERG
10,0 cm, 4"
14-2467-10



WALTON
14,0 cm, 5 1/2"
14-2468-14



FOX
14,0 cm, 5 1/2"



Lupusküretten
Lupus curettes
Curetas para lupus
Raschiatoio perlupus



Nagel Instrumente
Nail Instruments
Instrumentos para uñas
Strumenti per unghie



059-1420-01

FINGERRING SÄGE
17,0 cm, 6 3/4"



059-1430-01

WALTON
16,0 cm, 6 1/4"



RADOLF
13,5 cm, 5 1/4"



NAGELZANGE
13,5 cm, 5 1/2"



NAGELZANGE
13,0 cm, 5"



14-2475-00

14-2475-01

NAGELZANGE
14,0 cm, 5 1/2"



Scharfe Löffel
Bone Curettes
Cucharillas cortantes
Curetta per ossa

Fig. 00000
14-2479-04

Fig. 0000
14-2479-03

Fig. 000
14-2479-02

Fig. 00
14-2479-01

Fig. 0
14-2479-00



LEMPERT
21,5 cm, 8 1/2"



HALLE
21,0 cm, 8 1/4"

Fig. 00
14-2480-02

Fig. 0
14-2480-01

Fig. 1
14-2480-11



DAUBEN SPECK
20,0 cm, 8"

Fig. 00
14-2481-02

Fig. 0
14-2481-01

Fig. 1
14-2481-11

Fig. 2
14-2481-12

Scharfe Löffel
 Bone Currettes
 Cucharillas cortantes
 Curetta per ossa



Fig. 1
 14-2482-11

Fig. 2
 14-2482-12

WILLIGER
 17,0 cm, 6 $\frac{1}{2}$ "

Fig. 0
 14-2483-00

Fig. 1
 14-2483-01

Fig. 2
 14-2483-02

WILLIGER
 14,0 cm, 5 $\frac{1}{2}$ "

Fig. 0/0/0
 14-2485-00
 14,0 cm, 5 $\frac{1}{2}$ "

Fig. 0/1
 14-2485-01
 14,0 cm, 5 $\frac{1}{2}$ "

Fig. 1/2
 14-2485-12
 14,0 cm, 5 $\frac{1}{2}$ "

MARTINI
 14,0 cm, 5 $\frac{1}{2}$ "
 14-2485-00



14-2486-13
 13,0 cm, 5"

14-2486-14
 14,0 cm, 5 $\frac{1}{2}$ "

14-2486-17
 17,0 cm, 6 $\frac{1}{2}$ "

VOLKMANN



JAN SEN
 15,0 cm, 6"
 14-2487-15



JAN SEN
 16,0 cm, 6 $\frac{1}{2}$ "
 14-2487-16

Dissektoren, Elevatoren
 Dissectors, Elevators
 Discadores, Elevadores
 Dissettori, Elevatori



WATSON-CHEYNE
 17,8 cm, 6 7/8"
 14-2488-17



MCDONALD
 19,0 cm, 7 1/2"
 14-2488-19



WILLIGER
 17,0 cm, 6 3/4"
 14-2492-17



WILLIGER
 16,0 cm, 6 1/4"
 14-2489-16



LANGENBECK
 20,0 cm, 8"
 14-2490-08



LANGENBECK
 20,0 cm, 8"
 14-2491-10

Raspatorien
 Raspatories
 Periostótomos
 Periostotomi



AD SON
 17,0 cm, 6 1/2"



8 mm
 14-2493-01



7 mm
 14-2493-02



7 mm
 14-2493-03



7 mm
 14-2493-04



ÖNIG
 15,5 cm, 6"
 14-2494-15



5 mm



LAMBOTTE
 21,0 cm, 8 1/4"



10 mm
 14-2494-10



15 mm
 14-2494-15



20 mm
 14-2494-20



25 mm
 14-2494-25



FARABEUF
 15,0 cm, 6"
 14-2495-15



12,5 mm

Raspatorien
Raspatories
Periostótomos
Periostotomi



Flachmeißel, Hohlmeißel, Osteotome
 Chisels, Gouges, Osteotomes
 Cinceles, Gubias, Osteótomos
 Scalpelli, Sgorbie, Osteotomi



8,0 mm	14-2504-08
10,0 mm	14-2504-10
12,0 mm	14-2504-12
14,0 mm	14-2504-14
16,0 mm	14-2504-16

13,5 cm, 5 1/4"



8,0 mm	14-2505-08
10,0 mm	14-2505-10
12,0 mm	14-2505-12
14,0 mm	14-2505-14
16,0 mm	14-2505-16

13,5 cm, 5 1/4"



8,0 mm	14-2506-08
10,0 mm	14-2506-10
12,0 mm	14-2506-12
14,0 mm	14-2506-14
16,0 mm	14-2506-16

13,5 cm, 5 1/4"



3,0 mm	14-2507-03
4,0 mm	14-2507-04
5,0 mm	14-2507-05
6,0 mm	14-2507-06

PART SCH
 13,5 cm, 5 1/4"

3,0 mm	14-2508-03
4,0 mm	14-2508-04
5,0 mm	14-2508-05
6,0 mm	14-2508-06

PART SCH
 13,5 cm, 5 1/4"

10,0 mm	14-2509-10
15,0 mm	14-2509-15
20,0 mm	14-2509-20
25,0 mm	14-2509-25

STILLE
 20,0 cm, 8"

Flachmeißel, Hohlimeißel, Osteotome
 Chisels, Gouges, Osteotomes
 Cinceles, Gubias, Osteótomos
 Scalpelli, Sgorbie, Osteotomi



STILLE
20,0 cm, 8"



STILLE
20,0 cm, 8"



ALEXANDER
18,0 cm, 7"



ALEXANDER
18,0 cm, 7"



SMITH-PETERSEN
20,0 cm, 8"



SMITH-PETERSEN
20,0 cm, 8"

Flachmeißel, Hohlmeißel, Osteotome, Hämmer
 Chisels, Gouges, Osteotomes, Mallets
 Cinceles, Gubias, Osteótomos, Martillos
 Scalpelli, Sgorbie, Osteotomi, Martelli



9,0 mm	14-2516-09
14,0 mm	14-2516-14
16,0 mm	14-2516-16
19,0 mm	14-2516-19
25,0 mm	14-2516-25

SMITH-PETERSEN
20,0 cm, 8"



9,0 mm	14-2517-09
14,0 mm	14-2517-14
16,0 mm	14-2517-16
19,0 mm	14-2517-19
25,0 mm	14-2517-25

SMITH-PETERSEN
20,0 cm, 8"



6,0 mm	14-2518-06
15,0 mm	14-2518-15
20,0 mm	14-2518-20
25,0 mm	14-2518-25
30,0 mm	14-2518-30
38,0 mm	14-2518-38
44,0 mm	14-2518-44
50,0 mm	14-2518-50

LAMBOTT
24,0 cm, 1/2"



6,0 mm	14-2519-06
15,0 mm	14-2519-15
20,0 mm	14-2519-20
25,0 mm	14-2519-25
30,0 mm	14-2519-30
38,0 mm	14-2519-38
44,0 mm	14-2519-44
50,0 mm	14-2519-50

LAMBOTTE
24,0 cm, 9 1/2"



COLLIN
20,0 cm, 8"
14-2520-20



PARTSCH
18,0 cm, 7"
14-2521-18

mit Bleifüllung
 lead filled head
 cabezal relleno de plomo
 testa di piombo



BERGMANN
24,0 cm, 9 1/2"
14-2522-24



Sterilisierzangen
Sterilizing Forceps
Pinzas para esterilización
Pinze per sterilizzazione



20,0 cm, 8"
14-2522-20



CHEATTLE
27,0 cm, 10⁵/₁₆"
14-2523-27



ROGGE
23,0 cm, 9"
14-2524-23



PYE-SMITH(HARRISON)
30,0 cm, 12"
14-2525-30



MAYO
14,0 cm, 5¹/₂"
14-2526-14



BUNT
12,0 cm, 4¹/₂"
14-2527-12

Schalen
Trays
Bandejas
Bacinelle

STANDZYLINDER

∅ 75 x 130 mm	14-2528-06
∅ 75 x 175 mm	14-2528-07
∅ 100 x 175 mm	14-2528-08
∅ 100 x 200 mm	14-2528-09

RUNDESCHALE

∅ 40,0 mm	14-1130-04
∅ 60,0 mm	14-1130-06
∅ 80,0 mm	14-1130-08
∅ 100,0 mm	14-1130-10
∅ 120,0 mm	14-1130-12
∅ 150,0 mm	14-1130-15

SPÜLSCHALE

165x55mm	0,75l	14-1133-00
175x70mm	1,00l	14-1133-10
225x100mm	2,00l	14-1133-20
240x 95mm	2,75l	14-1133-30
260x120mm	4,00l	14-1133-40
290x100mm	5,00l	14-1133-50
315x150mm	8,50l	14-1133-60
325x150mm	8,00l	14-1133-70
360x165mm	12,00l	14-1133-80
415 x 100 mm	14,00l	14-1133-90

NIERENSCHALE

170 mm	14-1140-17
250 mm	14-1140-25
275 mm	14-1140-27

Schalen
Trays
Bandejas
Bacinelle



INSTRUMENTENKÄSTCHEN	
200 x 150 x 25 mm	14-1200-01
260 x 180 x 30 mm	14-1200-02
300 x 220 x 30 mm	14-1200-03
350 x 220 x 40 mm	14-1200-04
220 x 170 x 50 mm	14-1200-05
280 x 200 x 50 mm	14-1200-06
320 x 240 x 50 mm	14-1200-07
370 x 270 x 50 mm	14-1200-08
420 x 320 x 50 mm	14-1200-09



NAEDELDOSE

14-1300-00
Ø 65 x 17 mm
Außen- und Innendose
Exterior and interior box
Caja exterior e interior
Scatola esterna e interiore

14-1300-01
Ø 62 x 13 mm
Innendose allein
Interior box only
Caja interior, suelta
Scatola interiore sola



SPÜLSCHALEMIT
SKALIERUNG
25 ccm
14-310-25



SPÜLBECHERMIT
SKALIERUNG
50 ccm
14-310-50